

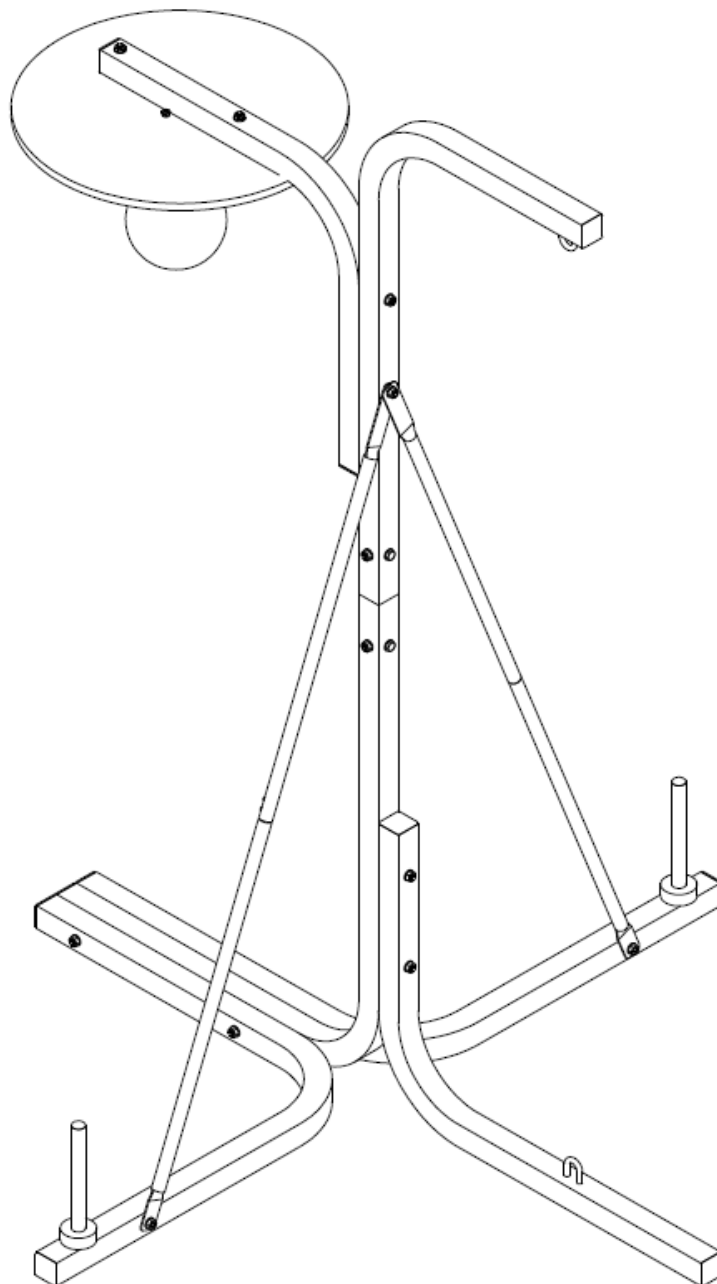







USER MANUAL – EN
IN 94 Boxing Rack inSPORTline



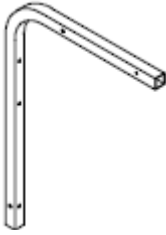

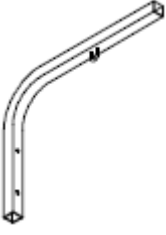
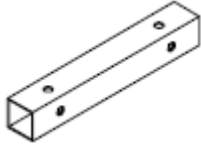
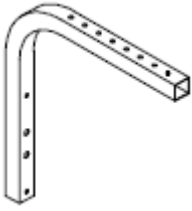
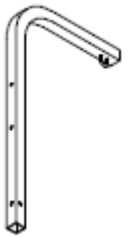

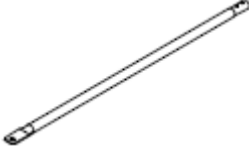

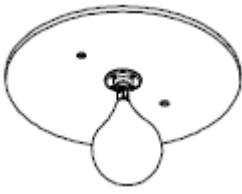
CONTENTS

PARTS LIST..... 3
 HARDWARE..... 3
EXPLODED VIEW 4
TERMS AND CONDITIONS OF WARRANTY, WARRANTY CLAIMS 5

PARTS LIST

Base Frame 	Left/Right Base Tube 	Front Base Tube 	Connection Tube 
A – 1 pc	B – 2 pcs	C – 1 pc	D – 1 pc
Speed Ball Platform Tube 	Fixing Tube 	Upper Incline Support 	Base Incline Support 
E – 1 pc	F – 1 pc	G – 2 pcs	H – 2 pcs
RP Tube 	Speed Ball Platform 		
I – 2 pcs	J – 1 pc		

HARDWARE

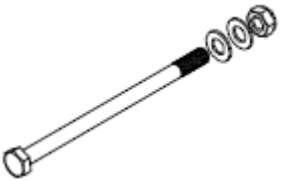
Phillips Bolt M6*16 	Phillips Bolt M10*65 + Washer (ø10) 	Phillips Bolt M10*80 + Washer (ø10) + Nut M10 	Hex Head Bolt M10*16 + Washer (ø10) 
1 – 4 pcs	2 – 2 pcs	3 – 2 pcs	4 – 4 pcs
Hex Head Bolt M10*65 + 2 Washers (ø10) + Nut M10 	Hex Head Bolt M10*115 + 2 Washers (ø10) + Nut M10 	Hex Head Bolt M10*120 + 2 Washers (ø10) + Nut M10 	Hex Head Bolt M10*165 + 2 Washers (ø10) + Nut M10 

5 – 4 pcs	6 – 3 pcs	7 – 1 pc	8 – 2 pcs
Buffer Ring			
			
9 – 2 pcs			

EXPLODED VIEW

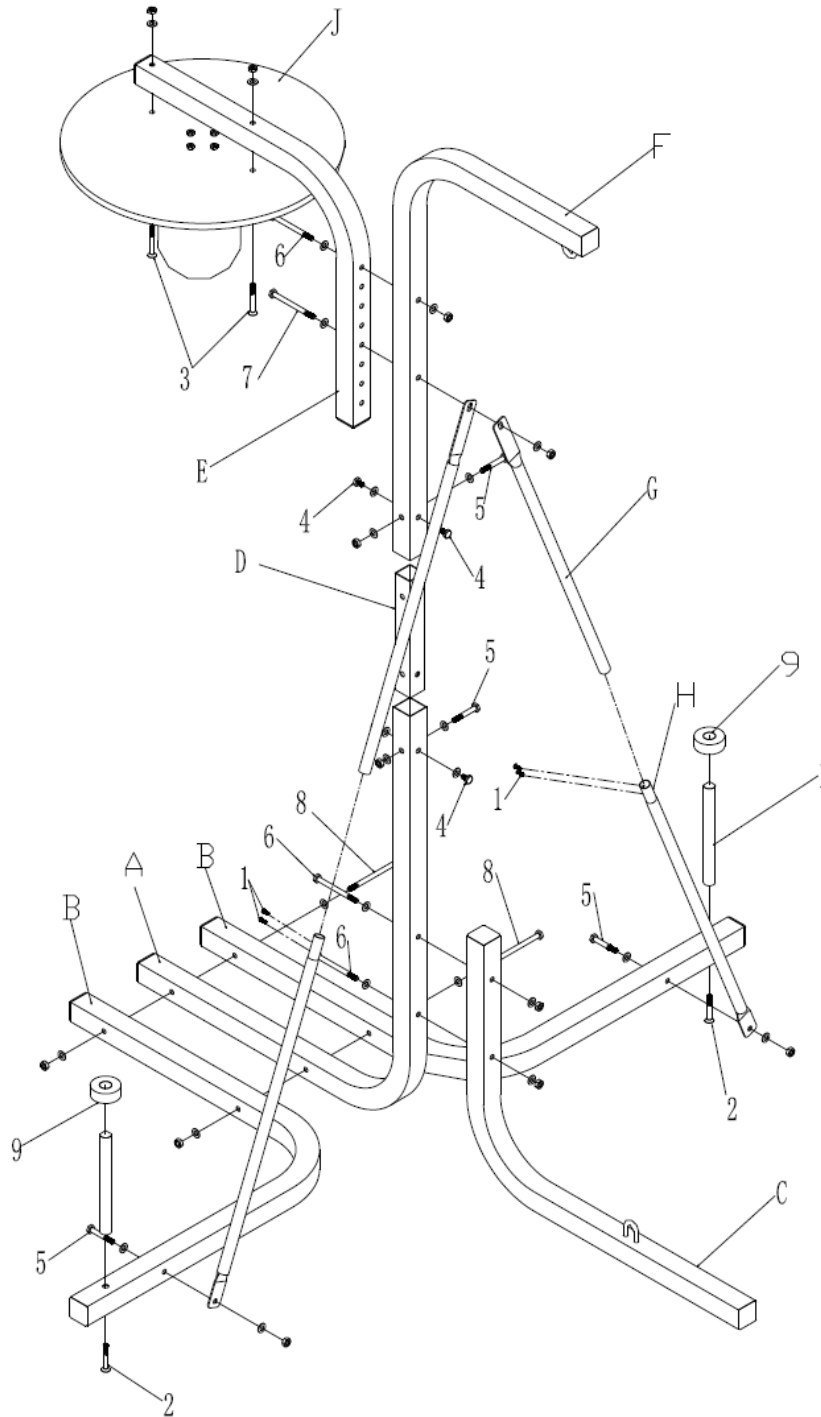

TERMS AND CONDITIONS OF WARRANTY, WARRANTY CLAIMS

General Conditions of Warranty and Definition of Terms

All Warranty Conditions stated hereunder determine Warranty Coverage and Warranty Claim Procedure. Conditions of Warranty and Warranty Claims are governed by Act No. 40/1964 Coll. Civil Code, Act No. 513/1991 Coll., Commercial Code, and Act No. 634/1992 Coll., Consumer Protection Act, as amended, also in cases that are not specified by these Warranty rules.

The seller is SEVEN SPORT s.r.o. with its registered office in Borivojova Street 35/878, Prague 13000, Company Registration Number: 26847264, registered in the Trade Register at Regional Court in Prague, Section C, Insert No. 116888.

According to valid legal regulations it depends whether the Buyer is the End Customer or not.

“The Buyer who is the End Customer” or simply the “End Customer” is the legal entity that does not conclude and execute the Contract in order to run or promote his own trade or business activities.

“The Buyer who is not the End Customer” is a Businessman that buys Goods or uses services for the purpose of using the Goods or services for his own business activities. The Buyer conforms to the General Purchase Agreement and business conditions to the extent specified in the Commercial Code.

These Conditions of Warranty and Warranty Claims are an integral part of every Purchase Agreement made between the Seller and the Buyer. All Warranty Conditions are valid and binding, unless otherwise specified in the Purchase Agreement, in the Amendment to this Contract or in another written agreement.

Warranty Conditions

Warranty Period

The Seller provides the Buyer a 24 months Warranty for Goods Quality, unless otherwise specified in the Certificate of Warranty, Invoice, Bill of Delivery or other documents related to the Goods. The legal warranty period provided to the Consumer is not affected.

By the Warranty for Goods Quality, the Seller guarantees that the delivered Goods shall be, for a certain period of time, suitable for regular or contracted use, and that the Goods shall maintain its regular or contracted features.

The Warranty does not cover defects resulting from:

User's fault, i.e. product damage caused by unqualified repair work, improper assembly, insufficient insertion of seat post into frame, insufficient tightening of pedals and cranks

Improper maintenance

Mechanical damages

Regular use (e.g. wearing out of rubber and plastic parts, joints etc.)

Unavoidable event, natural disaster

Adjustments made by unqualified person

Improper maintenance, improper placement, damages caused by low or high temperature, water, inappropriate pressure, shocks, intentional changes in design or construction etc.

Warranty Claim Procedure

The Buyer is obliged to check the Goods delivered by the Seller immediately after taking the responsibility for the Goods and its damages, i.e. immediately after its delivery. The Buyer must check the Goods so that he discovers all the defects that can be discovered by such check.

When making a Warranty Claim the Buyer is obliged, on request of the Seller, to prove the purchase and validity of the claim by the Invoice or Bill of Delivery that includes the product's serial number, or eventually by the documents without the serial number. If the Buyer does not prove the validity of the Warranty Claim by these documents, the Seller has the right to reject the Warranty Claim.

If the Buyer gives notice of a defect that is not covered by the Warranty (e.g. in the case that the Warranty Conditions were not fulfilled or in the case of reporting the defect by mistake etc.), the Seller is eligible to

require a compensation for all the costs arising from the repair. The cost shall be calculated according to the valid price list of services and transport costs.

If the Seller finds out (by testing) that the product is not damaged, the Warranty Claim is not accepted. The Seller reserves the right to claim a compensation for costs arising from the false Warranty Claim.

In case the Buyer makes a claim about the Goods that is legally covered by the Warranty provided by the Seller, the Seller shall fix the reported defects by means of repair or by the exchange of the damaged part or product for a new one. Based on the agreement of the Buyer, the Seller has the right to exchange the defected Goods for a fully compatible Goods of the same or better technical characteristics. The Seller is entitled to choose the form of the Warranty Claim Procedures described in this paragraph.

The Seller shall settle the Warranty Claim within 30 days after the delivery of the defective Goods, unless a longer period has been agreed upon. The day when the repaired or exchanged Goods is handed over to the Buyer is considered to be the day of the Warranty Claim settlement. When the Seller is not able to settle the Warranty Claim within the agreed period due to the specific nature of the Goods defect, he and the Buyer shall make an agreement about an alternative solution. In case such agreement is not made, the Seller is obliged to provide the Buyer with a financial compensation in the form of a refund.



SEVEN SPORT, s.r.o.

Borivojova 35/878 130 00 Praha 3, Czech Republic CRN: 268 47 264, VAT ID: CZ26847264

Orders: +420 556 300 970, objednavky@insportline.cz

Warranty Claims: +420 556 770 190, Mobile: +420 604 853 019, reklamace@insportline.cz

Service: +420 556 770 190, Mobile: +420 604 853 019, servis@insportline.cz

Fax: +420 556 770 192, (Service +420 556 770 191)

Web: www.insportline.cz, www.worker.cz, www.worker-moto.cz



INSPORTLINE, s.r.o.

Bratislavská 36, 911 05 Trenčín, Slovakia CRN: 36311723, VAT ID: SK2020177082

Orders: +421(0)326 526 701, +421(0)917 649 192, objednavky@insportline.sk

Warranty Claims: +421(0)326 526 701, +421(0)918 408 519, reklamacie@insportline.sk

Fax: +421(0)326 526 705

Web: www.insportline.sk, www.worker.sk, www.worker-moto.sk

Date of Sale:

Stamp and Signature of Seller: