

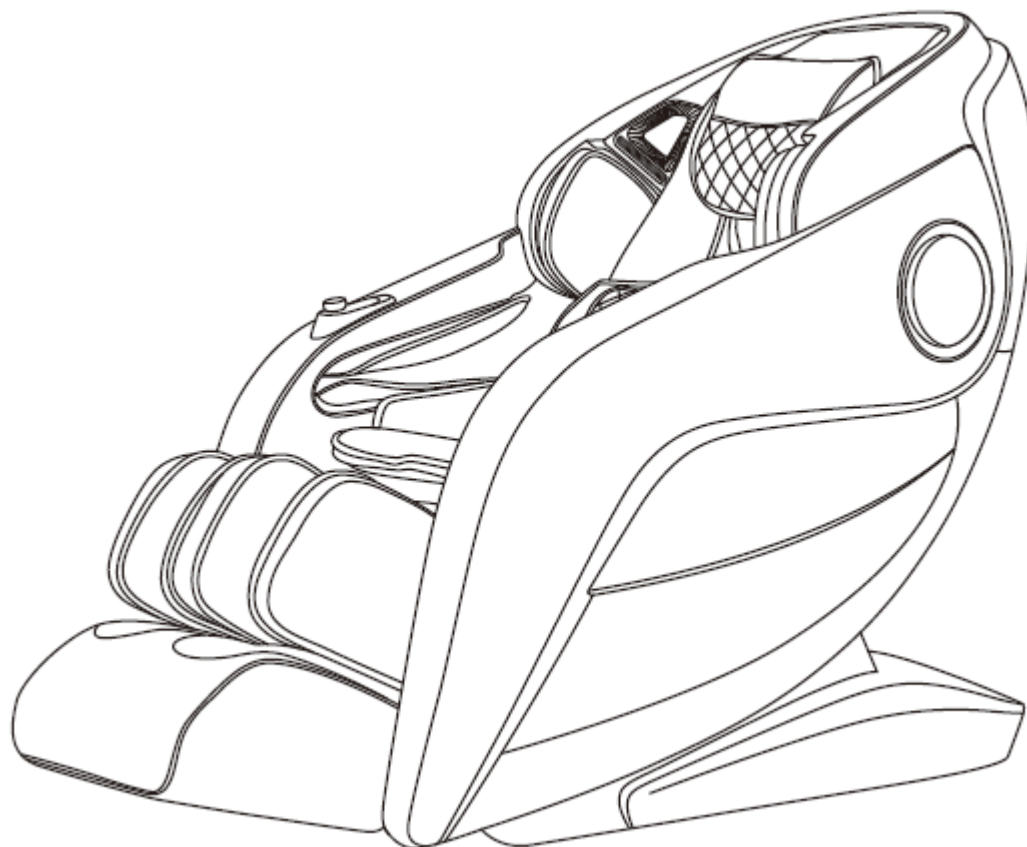

USER MANUAL – EN
IN 23647 Massage chair inSPORTline Marcelli



CONTENTS

- SAFETY INSTRUCTIONS..... 3
- WARNING 5
- PRODUCT DESCRIPTION 6
- FUNCTIONS..... 7
- CONTROLLER DISPLAY..... 8
- CONTROLLER BUTTONS..... 9
- USE 10
 - POWER UP AND START-UP 10
 - STANDBY MODE 10
 - STARTING THE MASSAGE 10
 - PAUSE 12
 - MENU..... 12
 - AUTOMATIC MESSAGE 13
 - MANUAL MODE 14
 - SPEED, WIDTH, AND INTENSITY ADJUSTMENT 19
 - PLACE / SCOPE OF MASSAGE..... 20
 - CUSTOM MESSAGE..... 21
 - SETTINGS 22
 - ARMREST CONTROLLER..... 26
- VOICE CONTROL..... 27
- SWITCH OFF THE CHAIR..... 27
- BLUETOOTH..... 27
- ASSEMBLY 28
 - ARMREST ASSEMBLY 28
 - LEG REST ASSEMBLY 29
- PILLOWS..... 31
- FLOOR PROTECTION..... 31
- TRANSPORT..... 31
- SPECIFICATIONS..... 32
- ENVIRONMENT PROTECTION 32
- TERMS AND CONDITIONS OF WARRANTY, WARRANTY CLAIMS..... 32

SAFETY INSTRUCTIONS

IMPORTANT SAFETY WARNINGS

- Place the product on flat and solid surface and keep at least 0.6 m free space around the product.
- Kids can move around this product only under adult supervision.
- Use only well-grounded socket and proper power cord.
- Pull out the plug after every use or during maintenance to avoid injury or damaging the product.
- Please use this product according to the manual.
- Do not use unauthorized modifications or accessories.
- Only for indoor use.
- Before first use, please read the manual carefully.
- Use this product as is described in the manual.
- Recommended maximum use time is 20 minutes.
- Do not use the device if it is damaged. (frame, leather etc.)
- Do not use the chair if the ventilation is blocked.
- No not put on chair heavy items or objects with sharp edge.
- Do not fall asleep during massage for safety reasons.
- Do not use the chair after you consumed alcohol or other drugs or if you are sick or dizzy.
- Do not use within one hour after meal.
- Please be caution and do not use too strong massage.
- Weight limit: 150 kg

POSITION OF MASSAGE CHAIR

- Do not use the chair in high temperatures or moist environments (e.g. bathroom).
- Do not use the chair immediately after temperature change.
- Do not use in dust or impropriety rooms.
- In is important to secure enough space and ventilation.

PEOPLE THAT SOULD NOT USE THE PRODUCT

- People suffering from osteoporosis.
- People who have hearth problems or are using electronic medical equipment (e.g. peacemaker).
- People suffering fever.
- Pregnant women.
- People suffering skin diseases.
- Kids younger 14 years old or people suffering mental illness can use this product only under adult supervision.
- People that are recommended rest from the doctor or people suffering from sickness.
- Do not use this chair if you have wet body.
- Do not use the heat function if you are heat sensitive.

SAFETY

- Maintenance should be done only by qualified person. User should not disassemble the chair or do the maintenance by themselves.
- After every use unplug the cord.
- Do not use the product if the power cord, plug or socket are damaged.
- If you are not using the chair for long period of time, store it at a clean and dry place and secure the power cord.
- Do not expose the chair to high temperatures, direct sunlight and do not place the chair near heat source.
- If the power cord, plug or socket are damaged, ask professional or qualified person for help.
- For cleaning use wet sponge only. Do not use thinner, gasoline or alcohol for cleaning.
- Mechanical parts are assembled and made to require minimum maintenance.
- Pay extra attention to not damage the chair with sharp objects.
- Do not push the chair on uneven ground, always pick the chair up and then move.
- Do not let the chair to work for long periods of time.

COMMON PROBLEMS AND SOLUTIONS

- It is common that the motor is making sounds.
- If the chair is not working, please check the power cord, plug and socket and that the switch is ON.
- After the massage time is over the massage chair will turn OFF. The product will automatically shut down if it is overheated – wait at least half an hour before next massage.

WARNING

If the footrest rises, do not apply pressure to the footrest. You may damage the product or injure yourself.

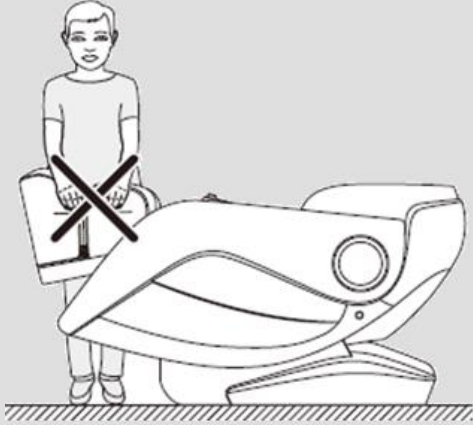

Before sitting down, make sure that the massage heads do not protrude from the seat. You may damage the heads or be injured.

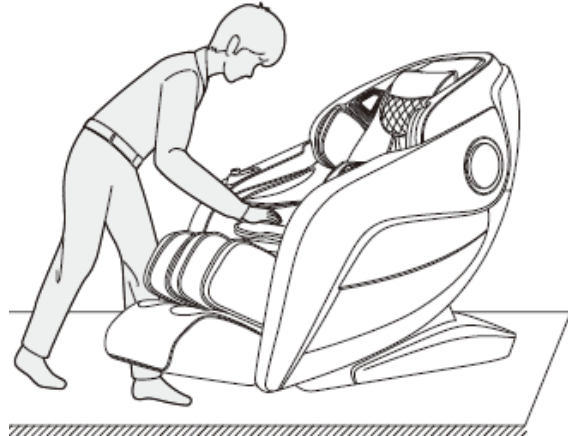

Never unplug the power cord during use or when the chair is in standby mode. After use, we recommend switching off the chair and unplugging the power cord.

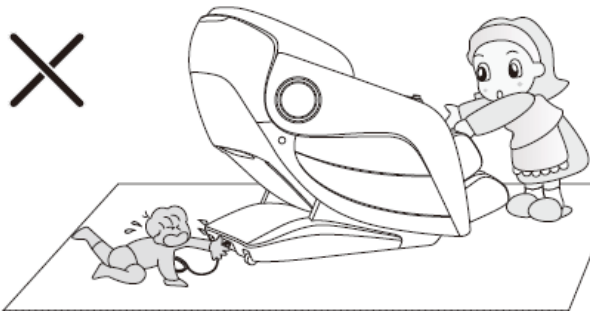

Before using the angle adjustment function, make sure that you have enough free space and that there are no other people or pets behind the chair.

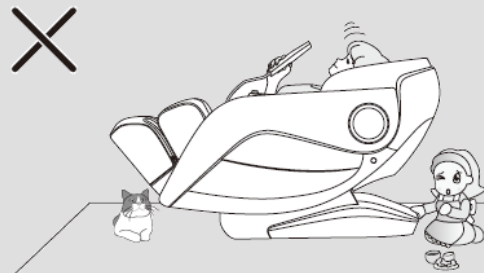

PRODUCT DESCRIPTION

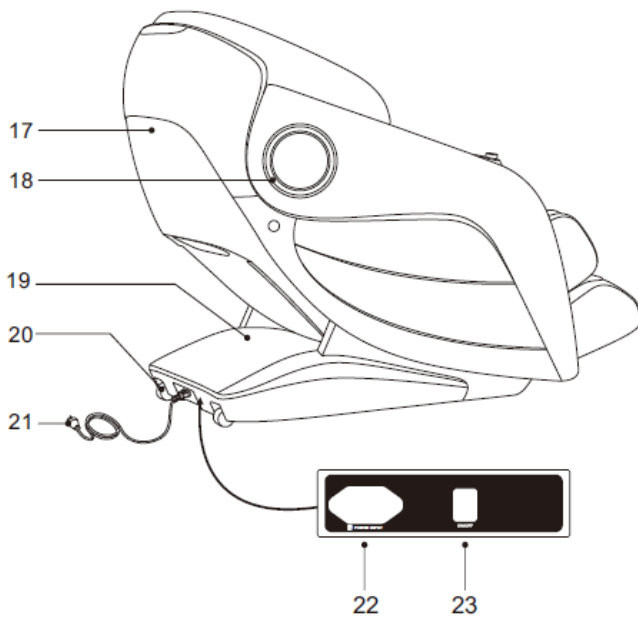
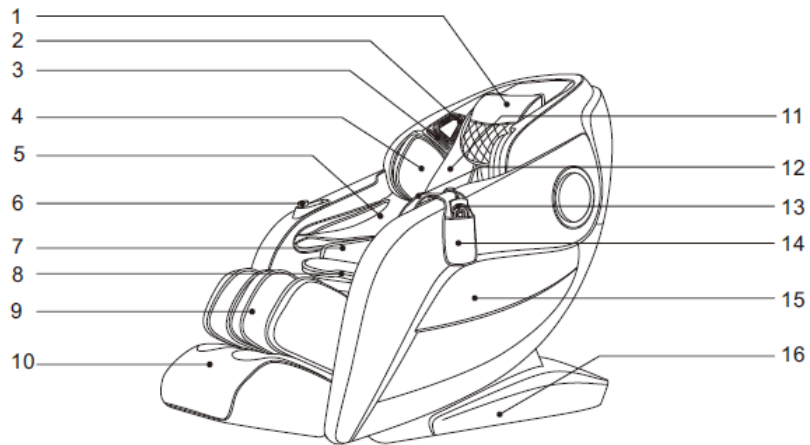

- 1. Pillow
- 2. 3D digital speakers with voice control on the left
- 3. O₂ Ionizer
- 4. Air cushions for upper arms
- 5. Air cushions for the lower arms
- 6. Quick setting buttons
- 7. Waist massage pillows
- 8. Seat cushion
- 9. Leg rest
- 10. Footrest
- 11. Backrest
- 12. Backrest air cushion
- 13. Controller
- 14. Pocket for the controller
- 15. Armrests
- 16. Side panel
- 17. Back panel
- 18. LED lights
- 19. PCB cover
- 20. Wheels
- 21. Power cord and plug
- 22. Armchair plug
- 23. Switch

FUNCTIONS

- The product was designed with smart and quiet 3D massage heads that can move up, down, forward, and backward.
- It can automatically detect the position of the shoulders, but you can also adjust the position yourself.
- It can perform a massage like a masseur by detecting the position and curves of the human body and moving the heads back and forth.
- It contains 8 types of massage: quick, comfortable, relaxing, stretching, full body massage, shoulder and neck massage, back and waist massage, total body massage with air cushions.
- The massage chair allows you to store up to 3 custom programs.
- Upper body massage; contains 5 massage positions: total massage, partial massage, massage of a specific part, upper and lower back; 5 types of massage: kneading, tapping, shiatsu, kneading and tapping, 3D massage; 5 speeds can be set; 5 levels of width for tapping and shiatsu programs.
- Air cushion massage: massage of the lower arm (8 cushions), upper arm (4 cushions) and 3 levels of intensity.
- Massage of air pads of the lower body: waist (4 pads), legs and hips (26 pads), feet (18 pads), 3 levels of intensity.
- Back and leg warmers use carbon fiber as a source of infrared heating.
- The chair moves forward when the backrest is tilted.
- The backrest uses technology that copies the shape of the spine.
- Voice control functions (on the left speaker).
- Music playback: 3D digital speakers on the right and left.
- Waist release: use the left and right cushions to swing the waist.
- On the right side there are quick buttons selection: start ionization, lift, lower, tilt, pause, automatic selection, foot adjustment, foot position adjustment.
- Adjusting the position of the footrest and backrest.
- Foot massage: two pairs of massage rollers
- The footrest automatically detects the length of the feet. If the footrest is raised, the footrest automatically detects the most suitable head position.
- LED lighting.
- O2 ionization on the right.
- Adjusting the width of the upper arm massage.
- The massage head returns to its original position after use.
- Color TFT display and control panel.

CONTROLLER DISPLAY

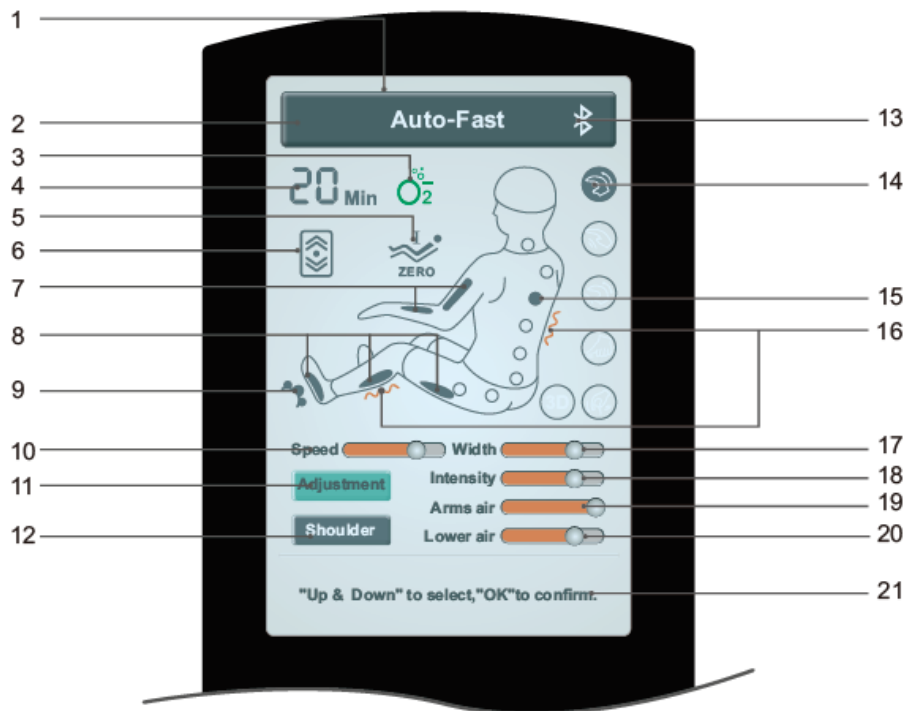

1.	TFT color display	12.	Adjusting the position of the shoulders
2.	The progress of the massage	13.	Bluetooth
3.	Ionization	14.	Type of massage
4.	Timer	15.	Massage location
5.	Tilt (zero gravity)	16.	Back and leg heating
6.	Tilt adjustment	17.	Width adjustment
7.	Arm cushion pressure	18.	Massage intensity
8.	Foot pad pressure	19.	The intensity of the air cushions of the arms
9.	Foot massage rollers	20.	Intensity of lower body air cushions
10.	Speed setting	21.	State
11.	Adjustment		

CONTROLLER BUTTONS

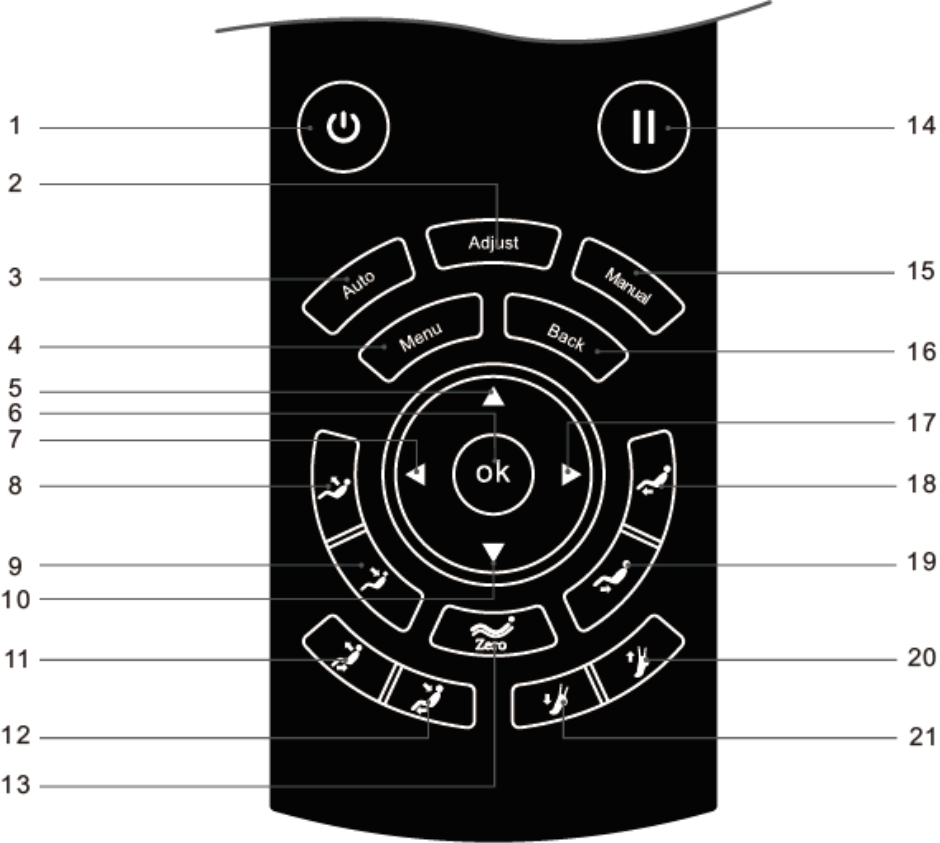

1. Power switch	12. Chair position - laying down
2. Adjusting the massage mode	13. Chair position - zero gravity
3. Automatic massage	14. Pause
4. Menu	15. Manual mode
5. Navigation button up	16. Return to the previous menu
6. Confirmation	17. Navigation button right
7. Navigation button left	18. Lifting the footrest
8. Lifting the armrest	19. Lowering the footrest
9. Lowering the backrest	20. Shortening of the footrest
10. Navigation key down	21. Footrest extension
11. Armchair position - seating	

USE

POWER UP AND START-UP

1. Plug in the socket

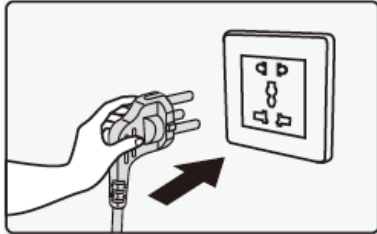

2. Plug in the chair

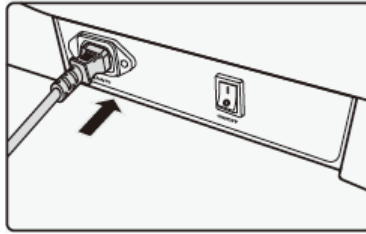

3. Turn the switch up

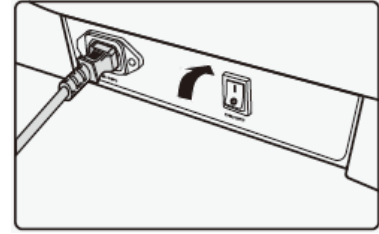

STANDBY MODE

No function can be selected in standby mode.

STARTING THE MASSAGE

Press the power button to start, the chair enters the loading screen, the backrest remains in its original position, the footrest is slightly raised, selecting massage from the automatic function starts the massage.

The chair will turn off automatically if no function is selected for 5 minutes.

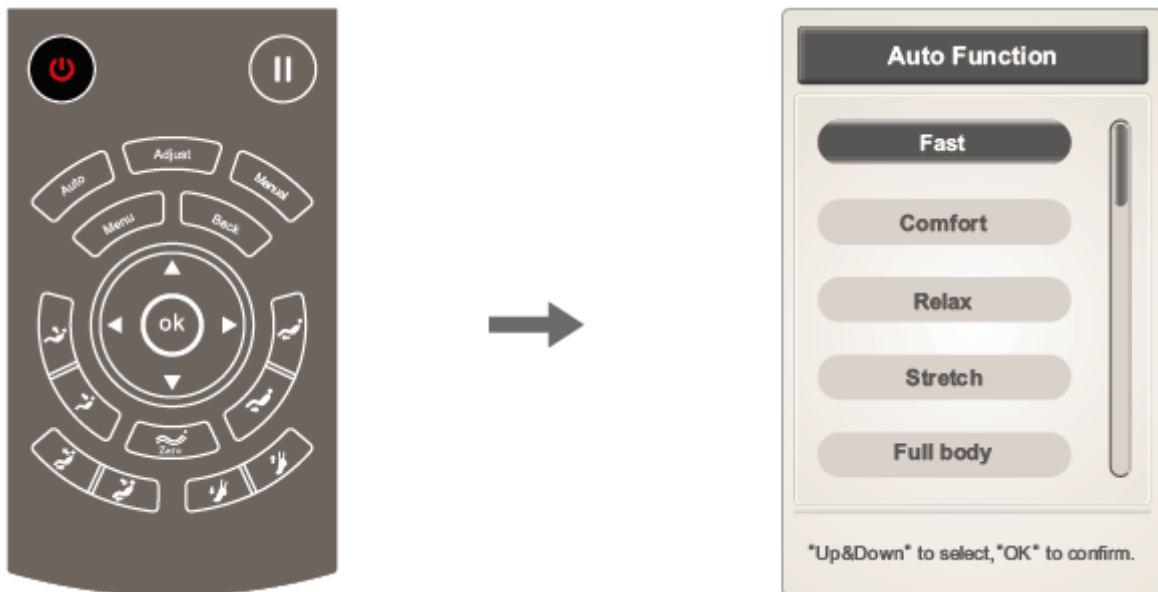

After selecting the automatic massage, the backrest and footrest are adjusted according to the selected massage.

After adjusting the backrest and leg rest, the chair automatically detects the position of the shoulders and body (note: quick mode detects only the position of the shoulders, other preset modes detect the position of the body and shoulders) wait for the chair to adjust all massage heads. If you press the button to confirm, the chair will start a massage in the original values of the position of the shoulders and body.

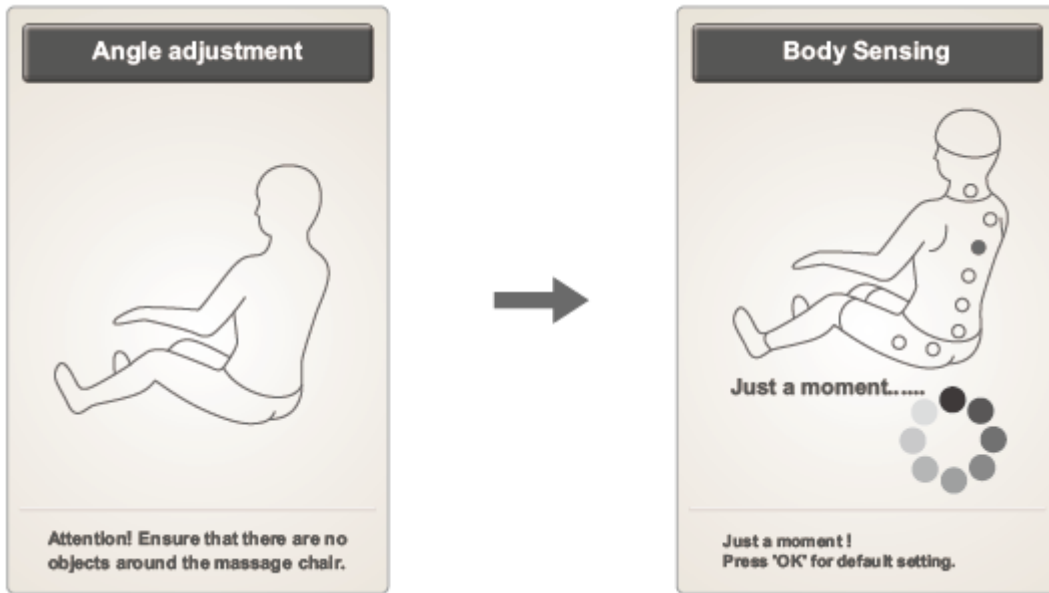

After setting the position of the shoulders, you will hear a sound signal, you can still adjust the position using the controller. The chair supports 11 levels of shoulder massage head positions. If you do not adjust the position within 10 seconds, the massage will start automatically. You can press the confirmation button to start immediately. If the selected program does not support automatic shoulder detection, the shoulder massage heads will be in their original position.

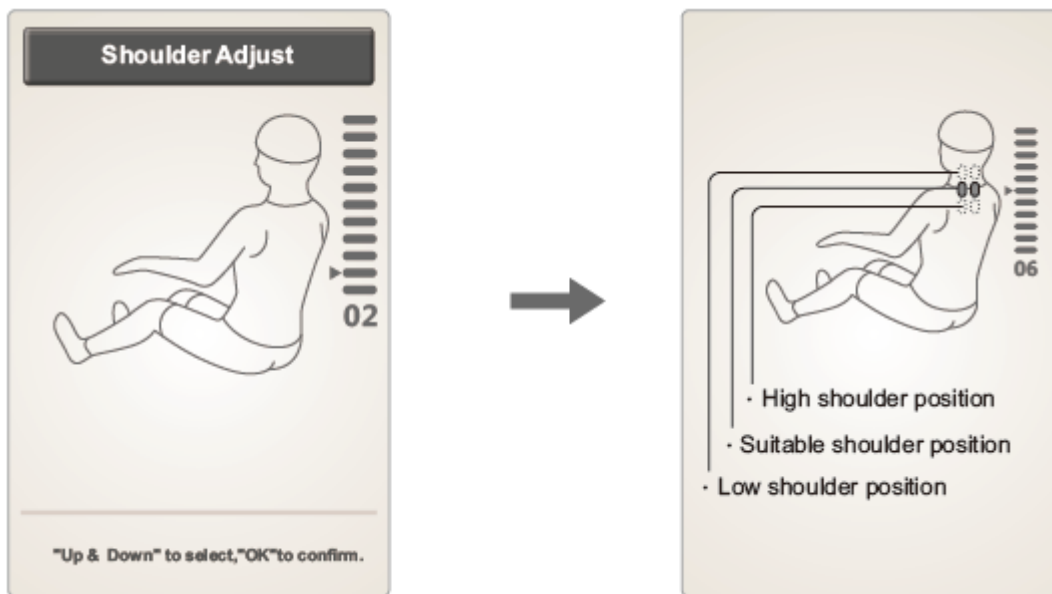

Button	Description
--------	-------------



Move the massage head up

Move the massage head down

After entering the massage modes, the position of the massage heads of the shoulders can be adjusted in the shoulder width interface.

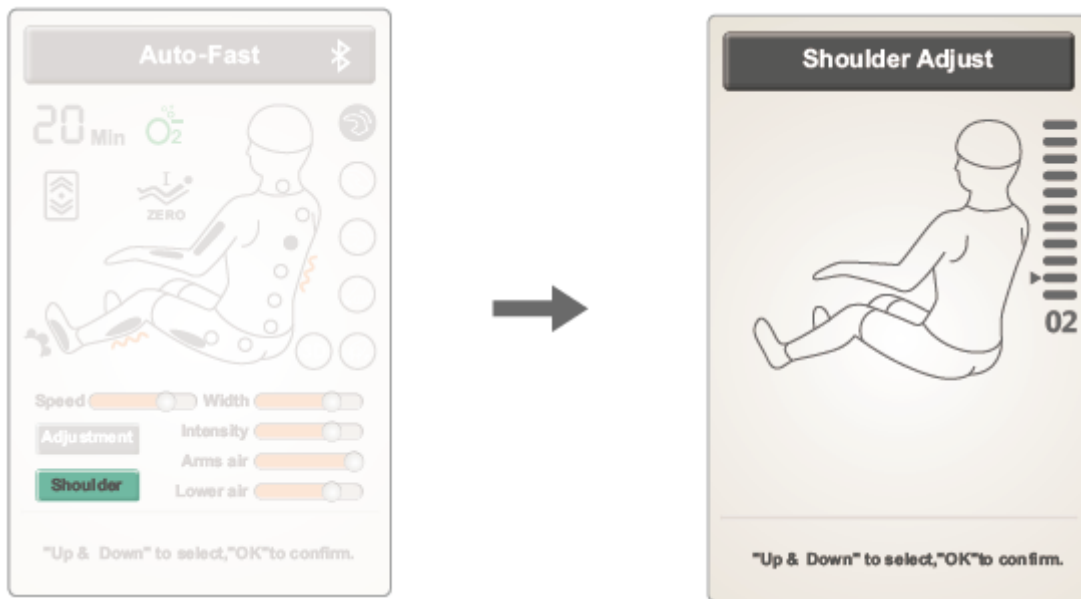

PAUSE

During the massage, you can press the "pause" button to pause the massage. Press again to start the massage. If the chair is paused for more than 20 minutes, the chair switches off.

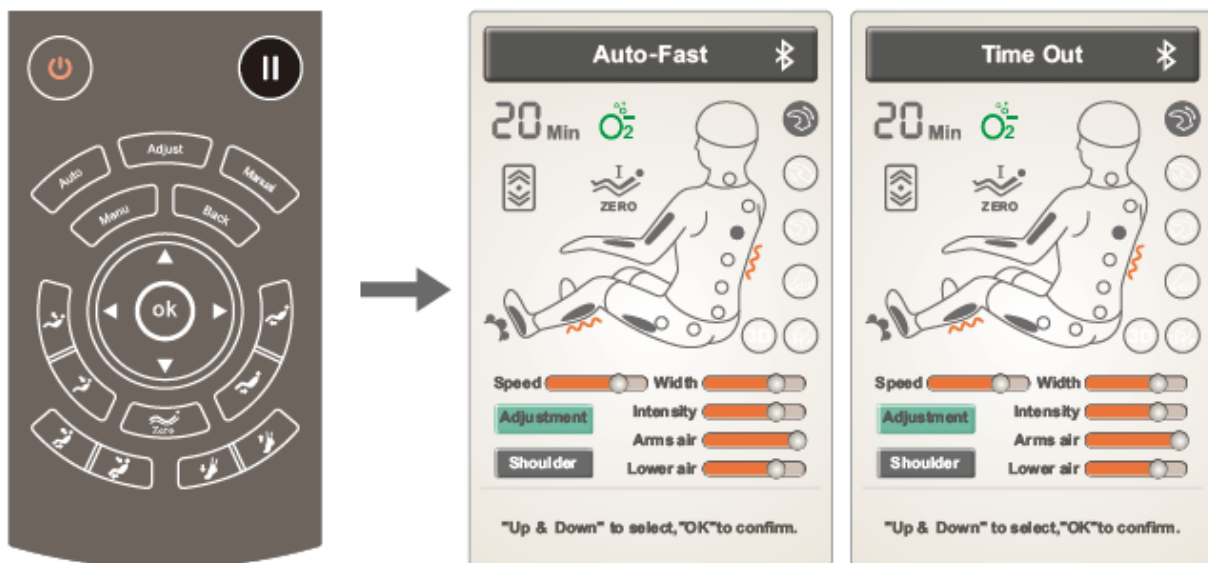

MENU

To enter the menu, press the "menu", in the interface you will find a selection of the type of massage: automatic, manual, adjustment, custom, settings and device information.

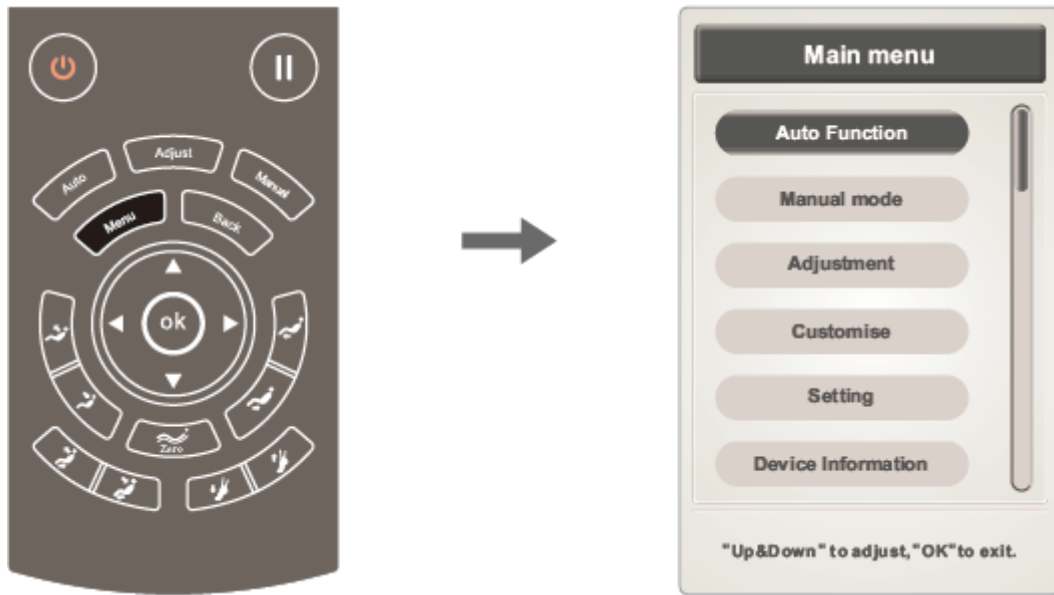

AUTOMATIC MASSAGE

To enter the automatic massage interface, you can enter via the menu or the "auto" button.

Press "menu", select auto, then choose one of the massages; fast, comfortable, relaxing, stretching, full body, shoulders, and neck, back and waist and pressure massage.

Navigate in the menu using the "up" and "down" buttons. Press "ok" to confirm the function. Press "back" to return to the previous interface.

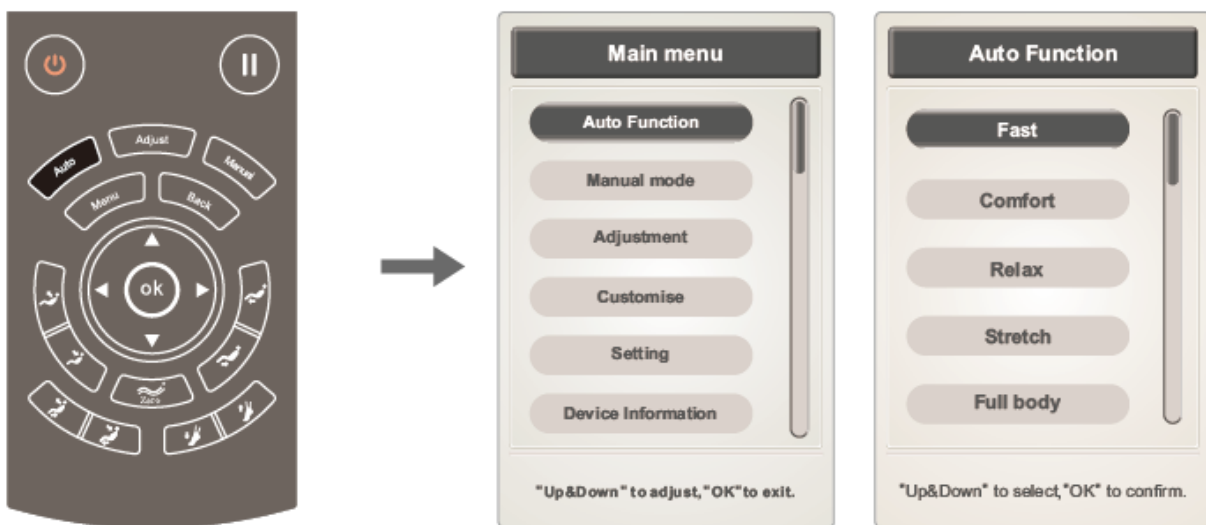

Note: During the automatic massage, the status of the massage is displayed, you can use "back" to see the progress.

Message type	Description
Fast	Quick full body massage
Comfortable	Comfortable full body massage
Relax	Gentle and deep full body massage for relaxation
Traction	Using air cushions, alternates left and right air cushions on the waist
Whole body	Deep full body massage

Neck and shoulder	Massage focused on the neck and shoulders
Back and waist	Massage focused on the back and waist
Full pressure	Massage to relax the limbs (arms, legs, feet)

MANUAL MODE

Press "menu" and select "manual mode" in the interface: the wise interface "massage type", massage area "massage position", air "massage pressure" and others "others" are displayed.

Use the right and left buttons to switch between the menus and use the up and down buttons to move between the options. Confirm the selection by pressing "ok". Press "back" to return to the previous interface.

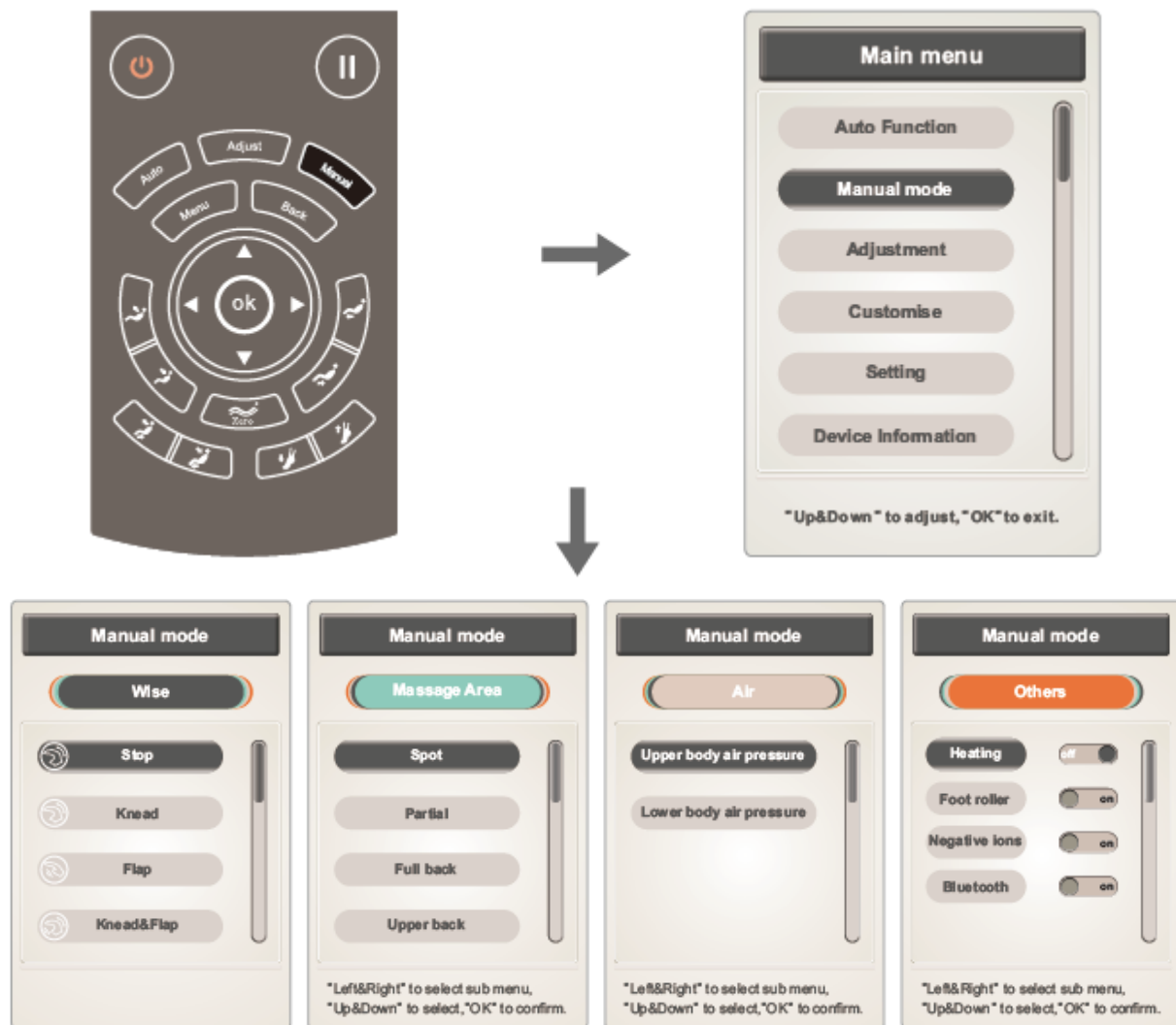

Manual mode

Manual mode contains 6 types of massages: kneading, tapping, kneading and tapping, shiatsu, 3D, shoulder massage. In tapping and shiatsu modes, you can adjust the width of the shoulder massage heads. You can adjust the speed.

Use the up and down buttons to select the type of massage, confirm the selection with the "ok" button.

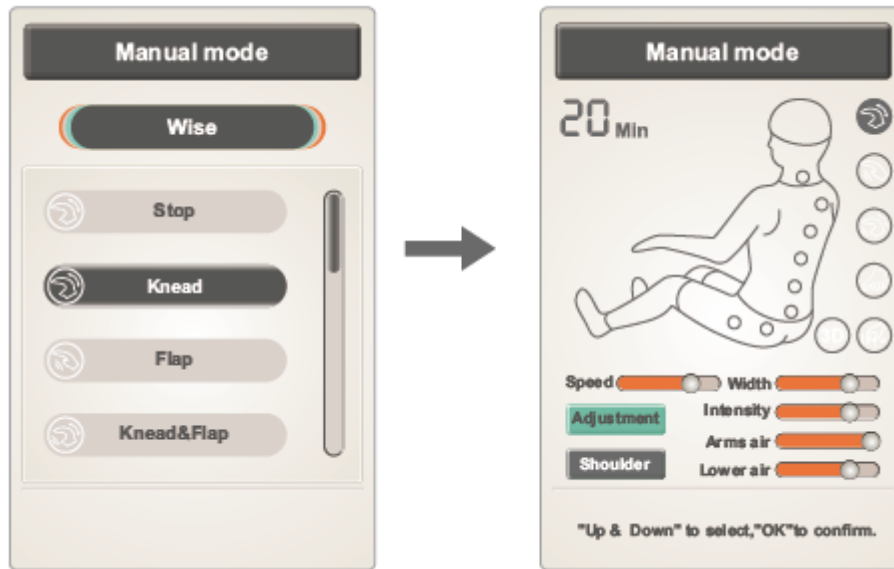

Note: Press stop to stop all functions.

Function	Description	
Kneading	Speed	
Tapping	Speed and width	
Kneading and tapping	Speed	5 levels of speed settings
Shiatsu	Speed and width	5 levels of width adjustment
Shoulder massage	Speed	
3D	Speed and width	

Fixed point massage

Fixed in one place, partial, whole back, upper and lower back.

Use the up and down buttons to select the type, confirm by pressing "ok".

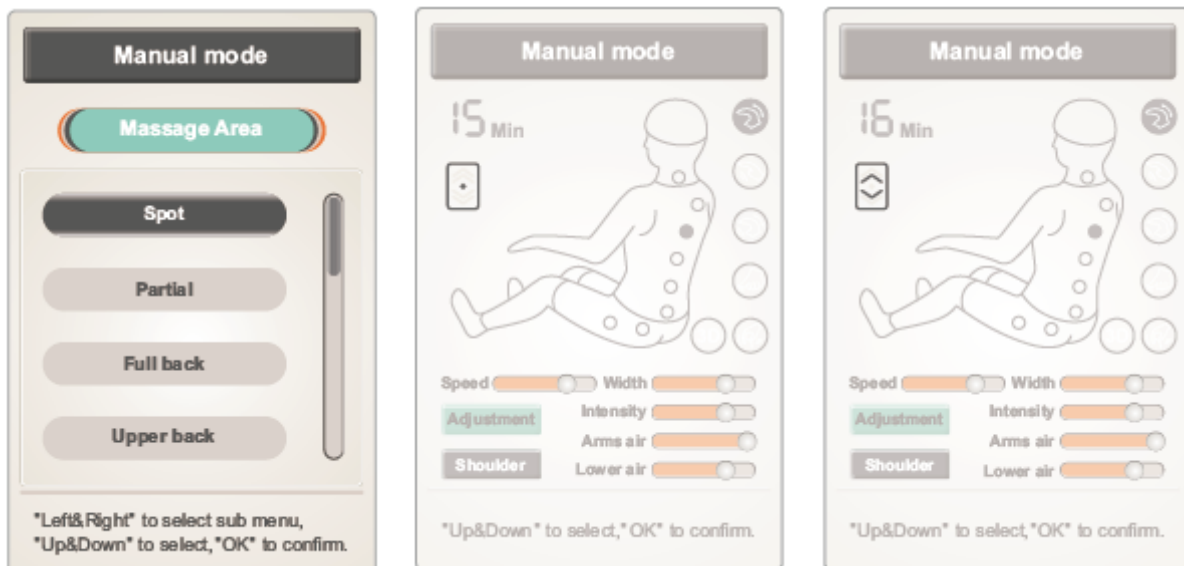

Fixed

Partial

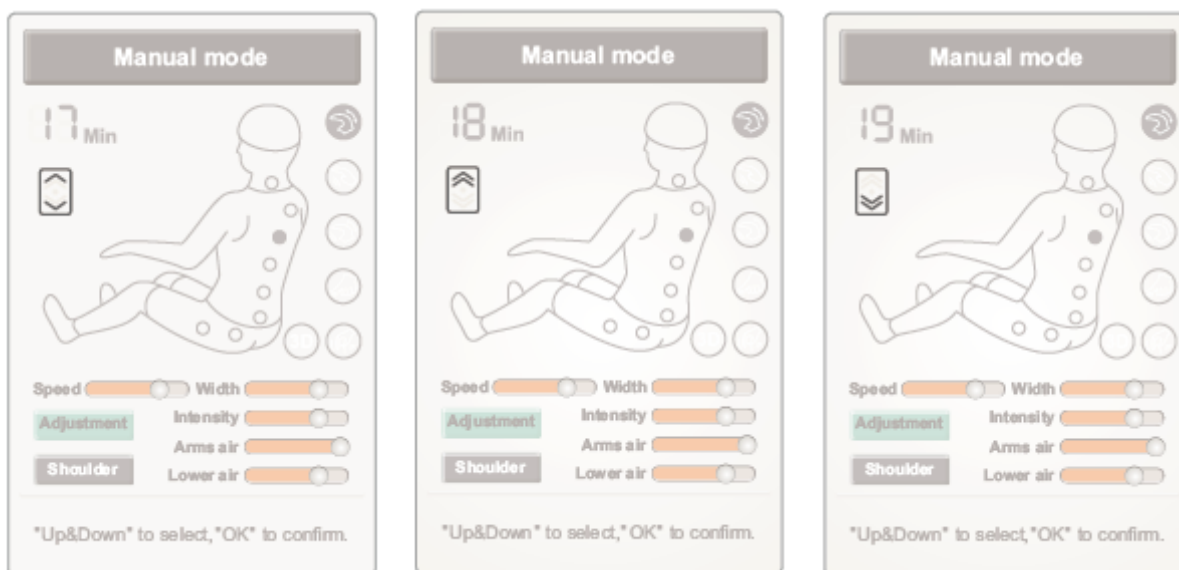

Whole back

Upper back

Lower back

Function	Description
Fixed	Massage in one place
Partial	Partial massage on a small scale
Upper back	Upper back massage
Lower back	Lower back massage
Whole back	Total massage

Air cushions

Upper or lower arm air cushions

Use the up and down buttons to select the function, confirm by pressing "ok".

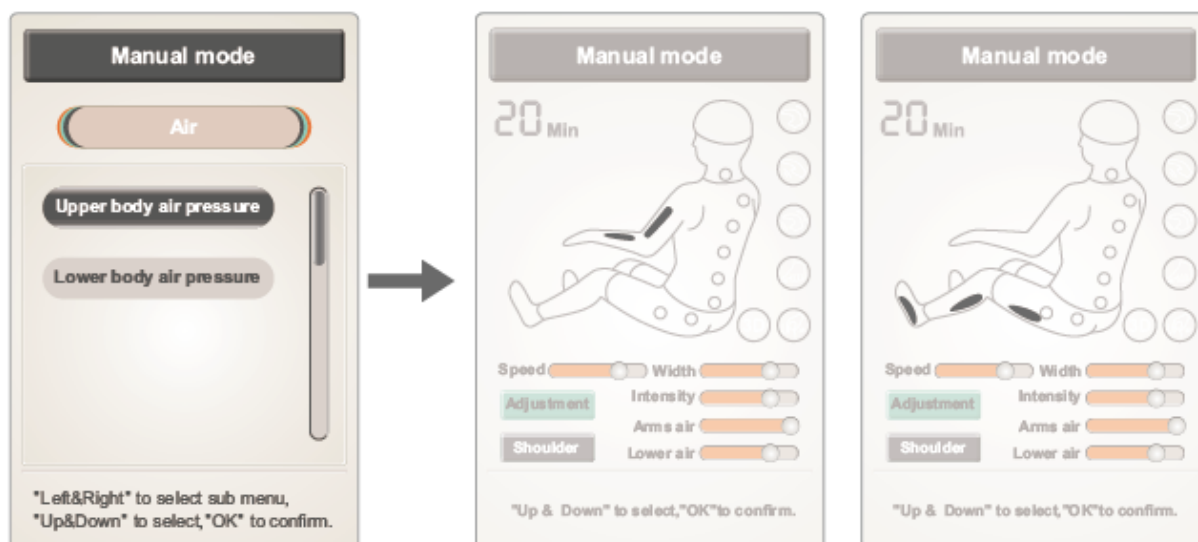

Function	Description
Upper arms	Start or turn off the function
Lower arms	Start or turn off the function

Others

Heating, foot massage rollers, ionization, Bluetooth

Use the up and down buttons to select the function, confirm by pressing "ok".

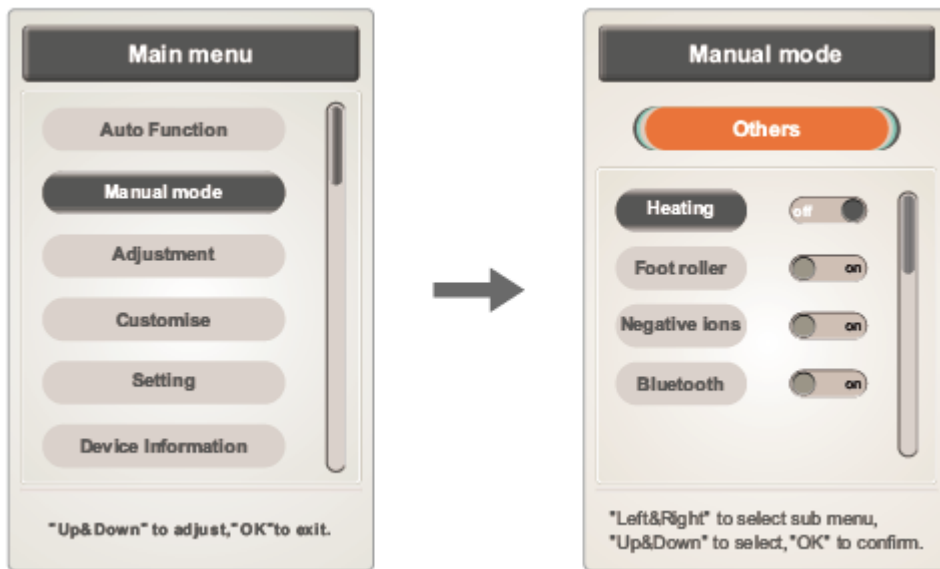

Use the up and down buttons to select the function, confirm by pressing "ok".

Press "confirm" to start / stop heating.

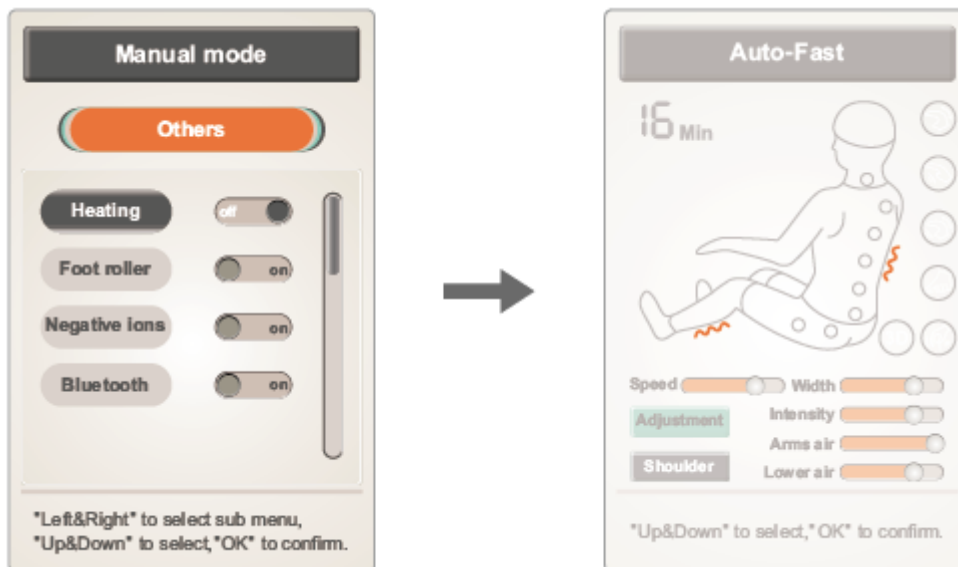

Use the up and down buttons to select the function, confirm by pressing "ok".

To start / stop foot massage, press "confirm".

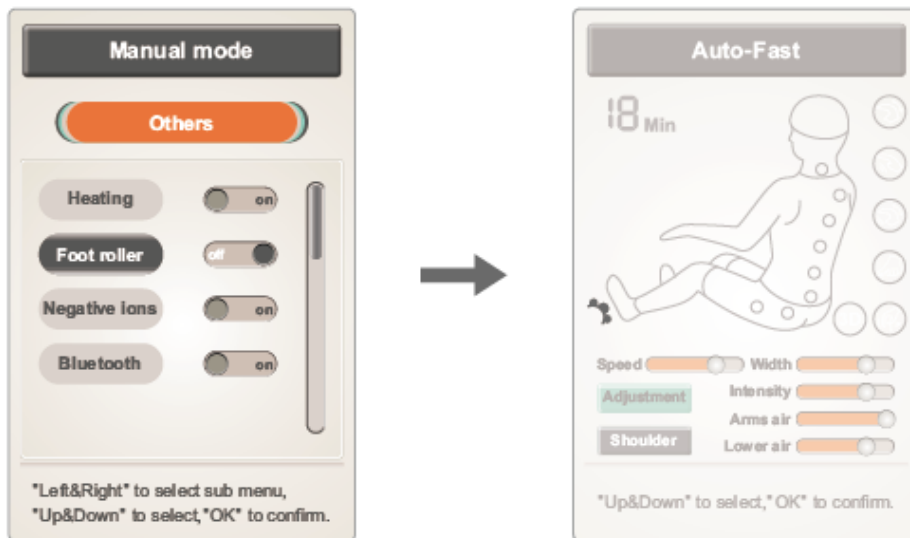

Use the up and down buttons to select the function, confirm by pressing "ok".

Press "confirm" to start / stop ionization.

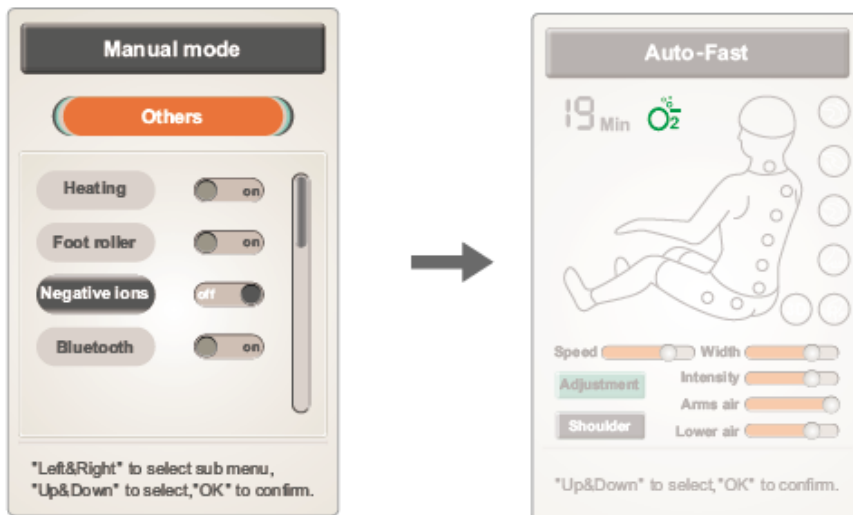

Use the up and down buttons to select the function, confirm by pressing "ok".

Press "confirm" to turn Bluetooth on / off.

You can use Bluetooth to play music.

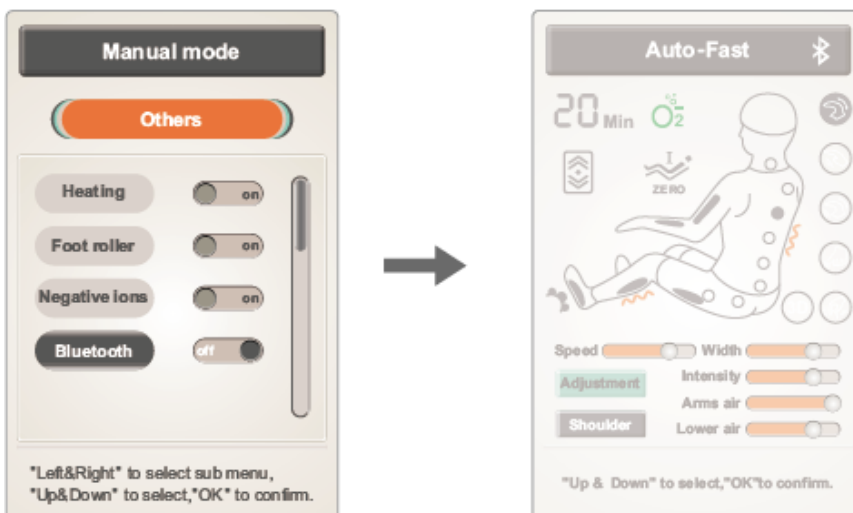

SPEED, WIDTH, AND INTENSITY ADJUSTMENT

In the main menu, select "adjustment".

An interface appears where you can select a function by pressing the up and down buttons and adjust their value by pressing the right and left buttons. After setting, confirm by pressing "ok" or return to the menu without changes by pressing "back".

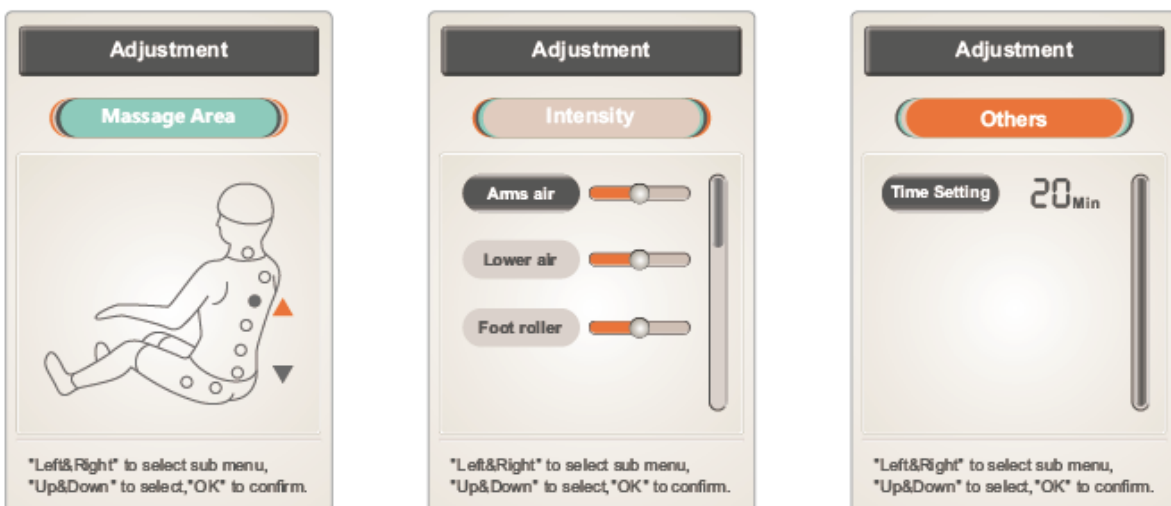
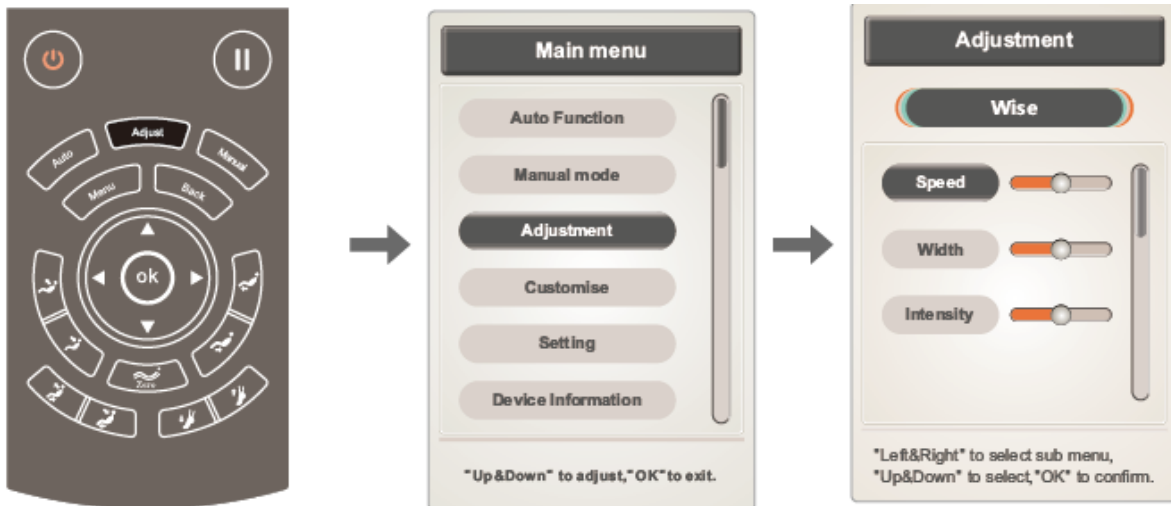

During operation, you can press the "adjust" button to enter the edit interface immediately.



You can adjust the speed, width, and intensity.

You can select the function with the up and down buttons, adjust the values with the right and left buttons. After setting, confirm by pressing "ok" or return to the menu without changes by pressing "back".



Note: Speed has 5 levels; The width has 5 levels for tapping and shiatsu modes

PLACE / SCOPE OF MASSAGE

You can set the place or range of the massage in single place massage or partial massage modes.

You can adjust the range using the up and down buttons.

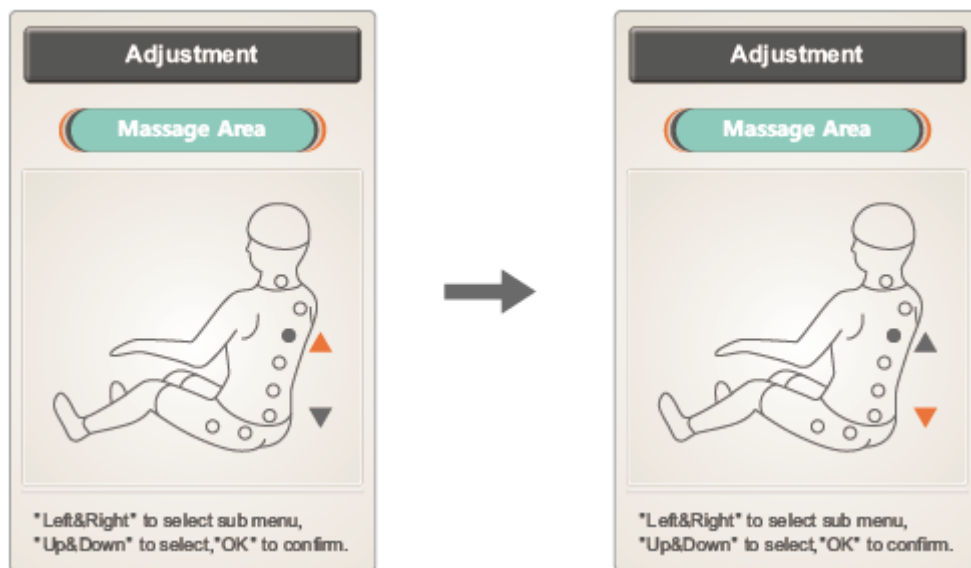

INTENSITY

In the upper and lower limbs massage modes, you can adjust the intensity of the air cushion and foot massage roller.

Use the up and down buttons to select a function, adjust the value by pressing right and left, confirm by pressing "ok"

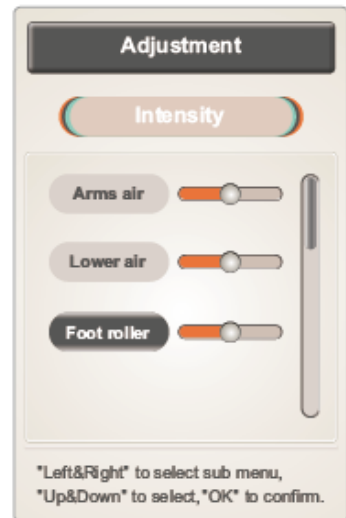
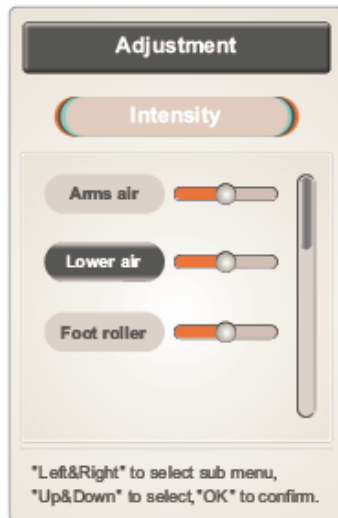
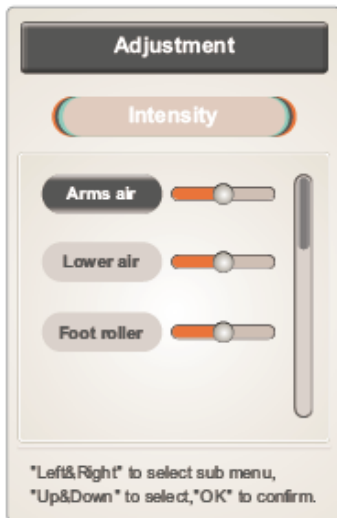

OTHER

Adjust the operating time, press "ok" to add 5 minutes. After adding more than 40 minutes, the time is reset. The minimum operating time must be 5 min.

Confirm the time by pressing "confirm".

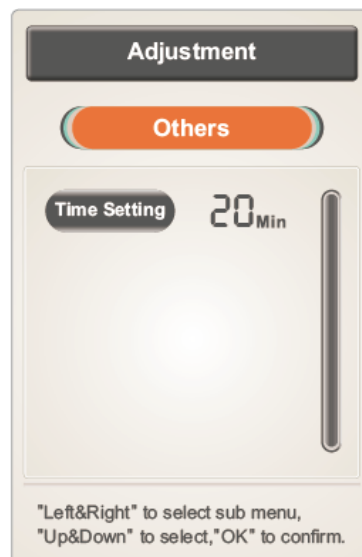

CUSTOM MESSAGE

Press "menu" and select "customize". An interface with 3 positions for saving the message is displayed.

Use the right and left buttons to select whether you want to save or load the settings. Confirm by pressing "ok".

Navigate in the interface using the up and down buttons.

Storage: save settings - type of massage, air cushion pressure, angle and more.

Transfer: upload settings - type of massage, air cushion pressure, angle and more.

Press "back" to return to the menu.

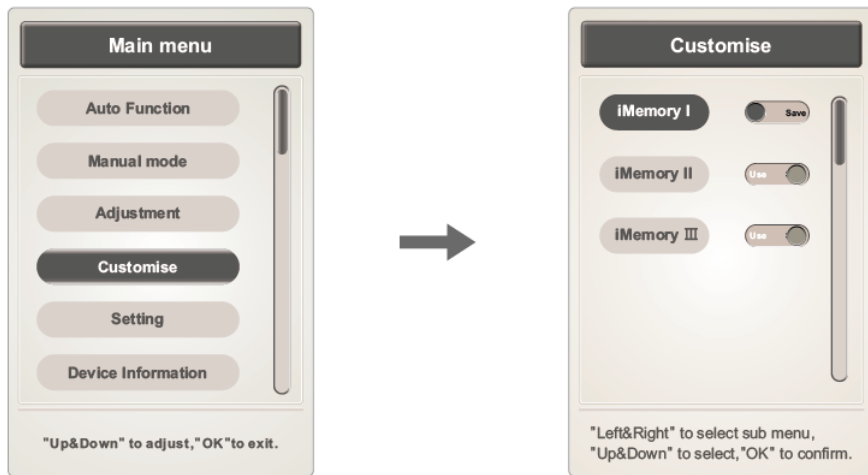

SETTINGS

Press "menu" and select "setting" to set the language, backlight, display power saving, etc.

In the menu, use the up and down buttons to navigate, and to change the value of the right and left buttons.

Press "back" to return.

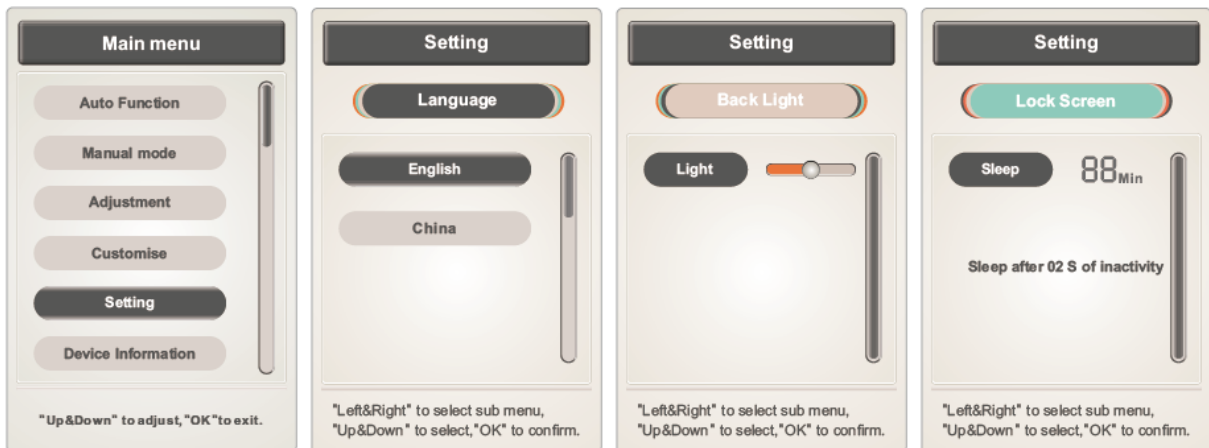

LANGUAGE

Language: select English or China

In the menu, use the up and down buttons to navigate.

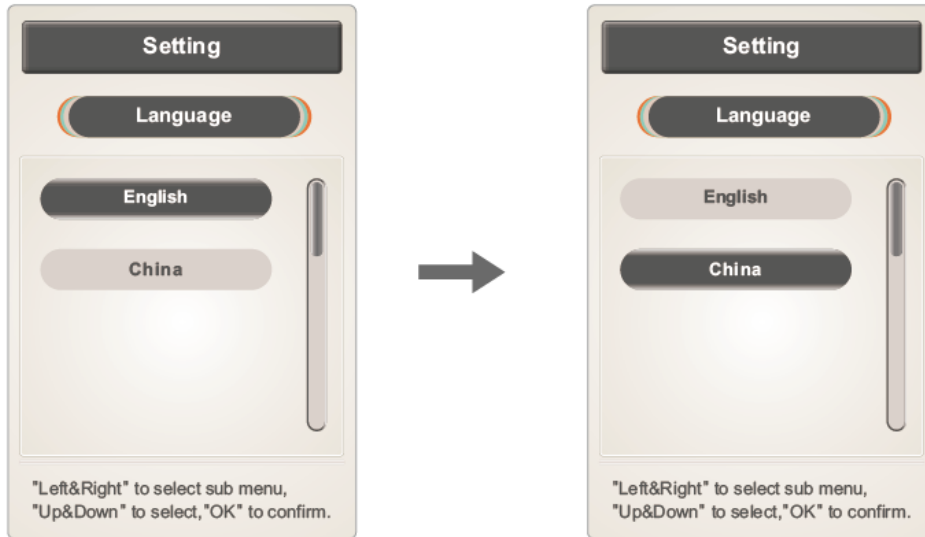

DISPLAY POWER SAVING

Lock screen: you can set the time, never turn off the screen, or automatically turn off the display after 2 seconds of inactivity.

To adjust the time, press "ok", you can set 15 seconds, 30 seconds, 1 min, 2 min or never switch off.

BACKLIGHT

You can set 5 levels of backlight.

Press "back" to return to the main menu.

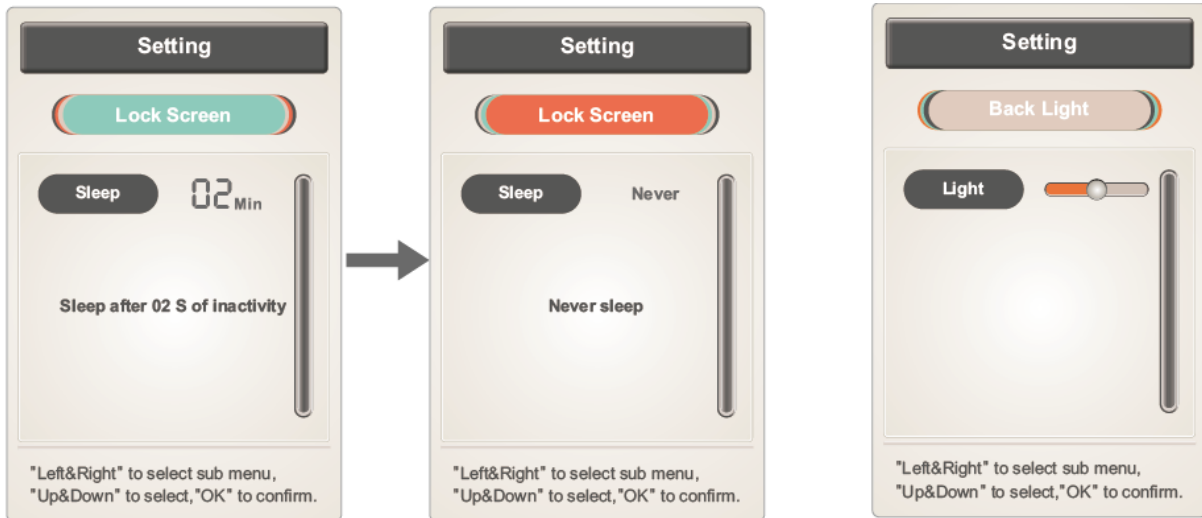

DEVICE INFORMATION

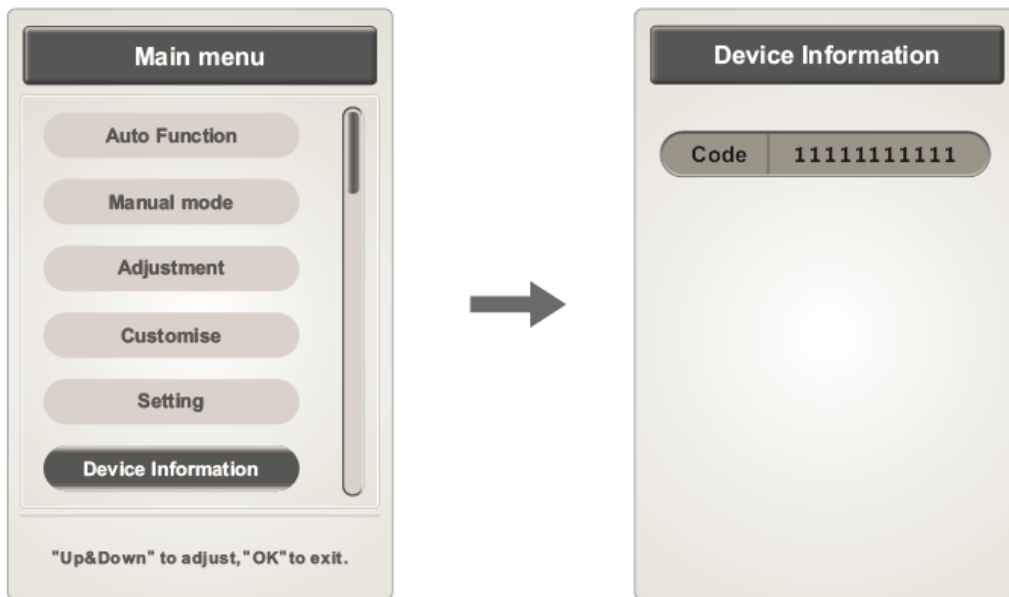

Press "menu" and select "Device information"

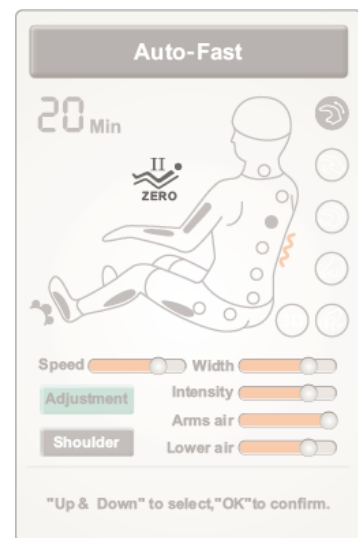

ZERO GRAVITATION SETTING

Press  and select "zero I" or "zero II"









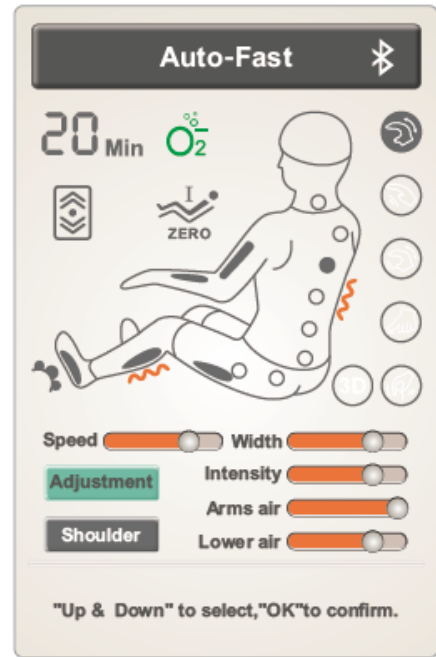
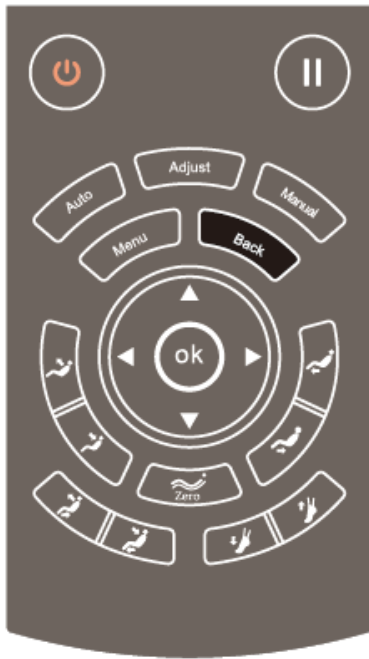

Dunction	Description
	Zero gravity I
	Zero gravity II

BACK BUTTON

The "back" button is used to display information about the massage.









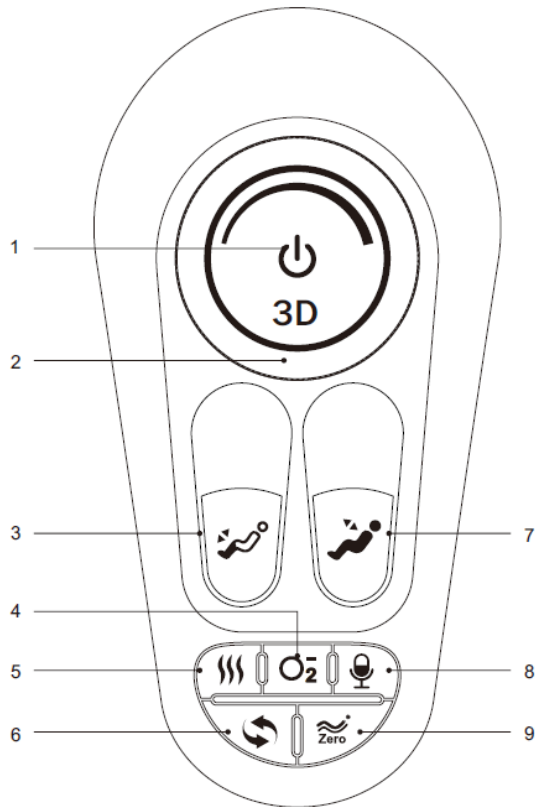

ADJUSTING THE ANGLE OF THE BACK AND LEG RESTS

Function	Description
	To raise the footrest: hold for lifting, release the button to stop. When done, it automatically detects the length of the legs.
	Lowering the footrest: hold to lower, release the button to stop. When done, it automatically detects the length of the legs.
	To raise the armrest: hold to lift, release the button to stop.
	Lowering the backrest: hold to lower, release to release to stop.
	Raise the backrest and lower the footrest, release the button to stop. When done, it automatically detects the length of the legs.
	Lowering the backrest and raising the footrest, release the button to stop. When done, it automatically detects the length of the legs.
	Press to switch the chair to zero gravity mode. The chair supports two positions.
	Shortening the footrest, release the button to stop.
	To extend the footrest, release the button to stop.

ARMREST CONTROLLER



1. Power button: press to turn the chair on / off
2. 3D massage: change the intensity of the 3D massage
3. Adjusting the length of the footrest
4. Ionization: press to turn on / off
5. Heating: press to switch on / off
6. Automatic massage: press to switch on / off
7. Adjusting the angles of the armrests
8. Voice control: press to turn on / off
9. Zero gravity angle settings

Function	Description
	Power button: press to pause / start the massage, hold for 3 seconds to start / stop the chair. If the pause is longer than 20 minutes, the chair switches off automatically.
	3D massage intensity setting: 3D massage intensity
	Shortening the footrest: hold the button to change, release the button to stop
	To extend the footrest: hold down the button to change, release the button to stop
	Raising the armrest and lowering the footrest: hold down the button to change, release the button to stop
	Lowering the backrest and raising the footrest: hold down the button to change, release the button to stop
	Start or stop heating
	Start or stop ionization
	Start or stop voice control of the chair
	Start or stop the automatic massage



Zero gravity position setting. Two positions.

VOICE CONTROL

Voice control of the chair is in English only.

If the chair is turned on or in standby mode, say "Hi Alice" to start voice control. After starting the voice control, you have 6 seconds to enter the next command. After 6 seconds, the voice control switches off again.

No.	Command	Answer
1.	Massage on	ok, massage on.
2.	Massage close	ok, massage close
3.	Comfort Massage.	ok, comfort massage
4.	Relax massage.	ok, relax massage
5.	Full body massage.	ok, full body massage
6.	Neck and shoulder massage.	ok, Neck and shoulder massage
7.	Back and waist massage.	ok, back and waist massage
8.	Stretch massage.	ok, stretch massage
9.	Fixed massage.	ok, fixed massage
10.	Change the other mode.	ok, change the other mode
11.	Go little down.	ok, go little down
12.	Go little up.	ok, go little up
13.	Open the air pressure.	ok, open the air pressure
14.	Close the air pressure.	ok, close the air pressure
15.	Up the seat position.	ok, up the seat position
16.	Down the seat position.	ok, down the seat position
17.	Stop adjustment.	ok, stop adjustment

SWITCH OFF THE CHAIR

Press the power button to turn off the chair. The massage functions are switched off, the positions of the armrests are switched to the default positions.

To switch off completely, switch the switch on the left side of the chair to the off position.

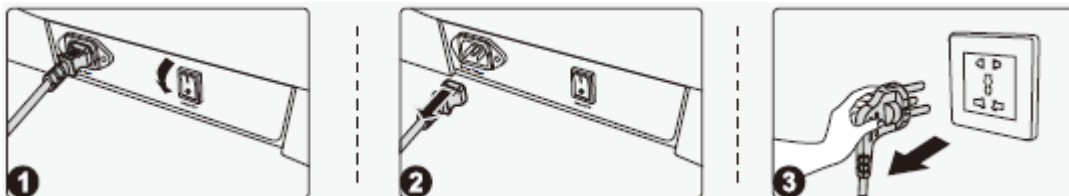

BLUETOOTH

Start Bluetooth on the chair as described in MANUAL MODE - OTHERS. Find your new device on your phone. The chair will be called IMCM-XXXX (X is the unique number of the chair). Pair the chair with your phone and you can play music from your phone.

ASSEMBLY

ARMREST ASSEMBLY

Locate the connectors and extend from the bottom to the center of the rear frame the end of the chair (Fig. 1).

Then connect the connectors (Fig. 2).

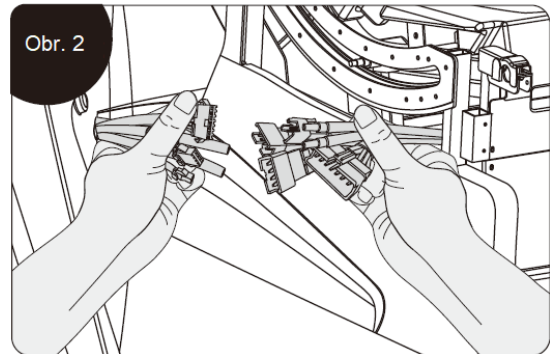
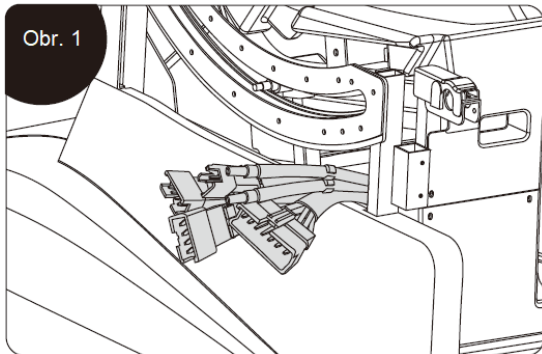

Connect the air hoses (Fig. 3).

After connecting all the parts, carefully insert the cables and air hoses into the chair. Be careful not to pinch any parts (Fig. 4).

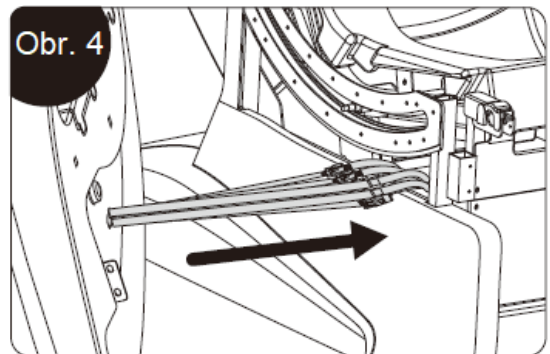
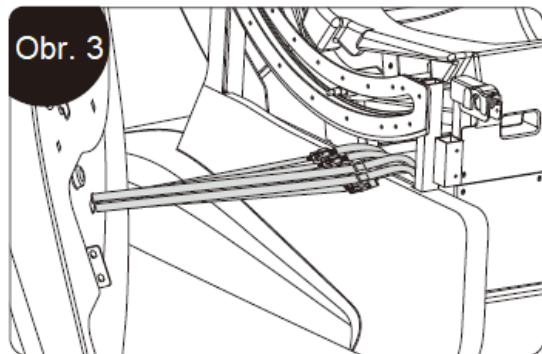

Then attach the armrests from front to back (Fig. 5).

Attach the armrest to the overhangs (Fig. 6).

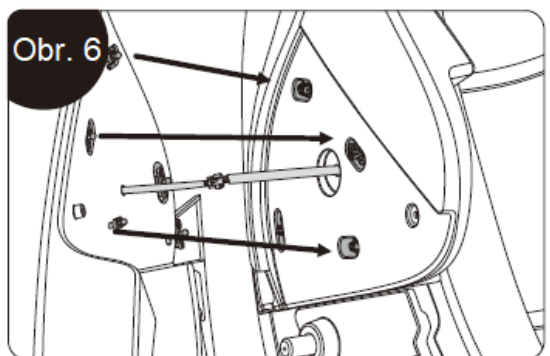
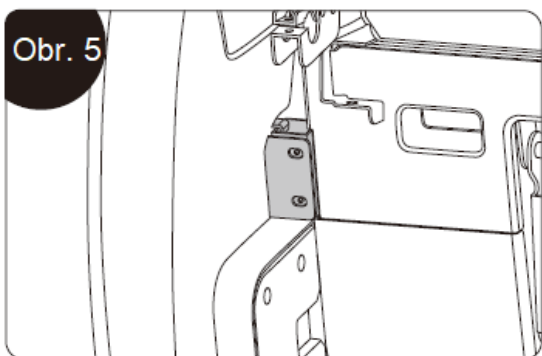

Tighten the back of the backrest with an M6x20 screw (Fig. 7).

Then remove the cover on the top of the backrest and fasten with M5x16 screws (Fig. 8).

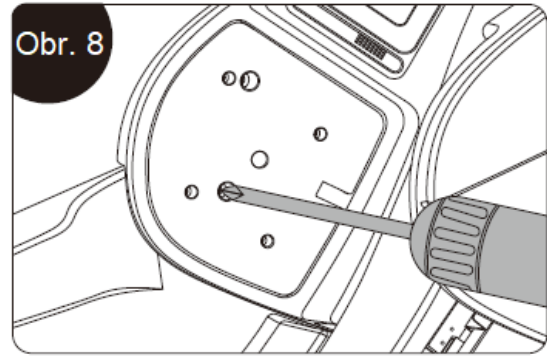
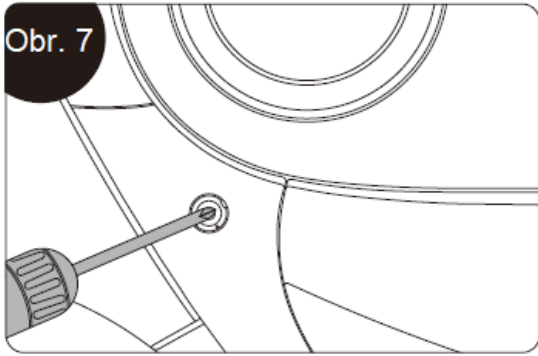

Attach the support to the metal frame with M5x16 screws (Fig. 9).

Attach the cover (Fig. 10).

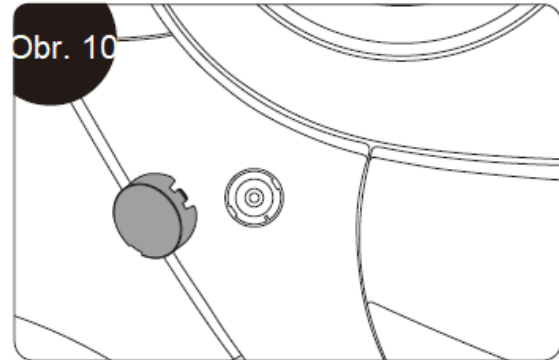
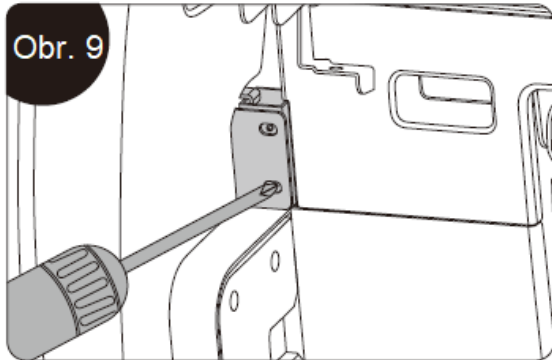

LEG REST ASSEMBLY

Attach the air hoses (Fig. 1).

Attach the hoses and cables and then insert them into the chair frame. Be careful not to pinch the cables and hoses (Fig. 2).

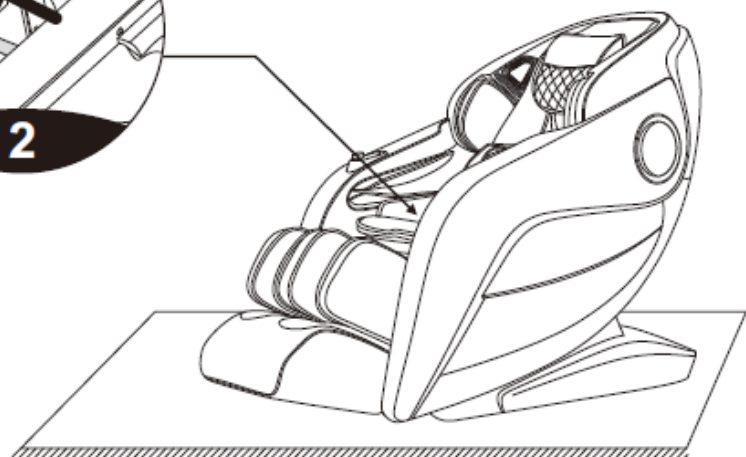
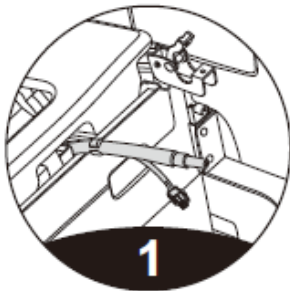

Attach the sleeves to the brackets (the larger sleeve must be on the outside) (Fig. 3).

Pull out the leg rest holder (Fig. 4).

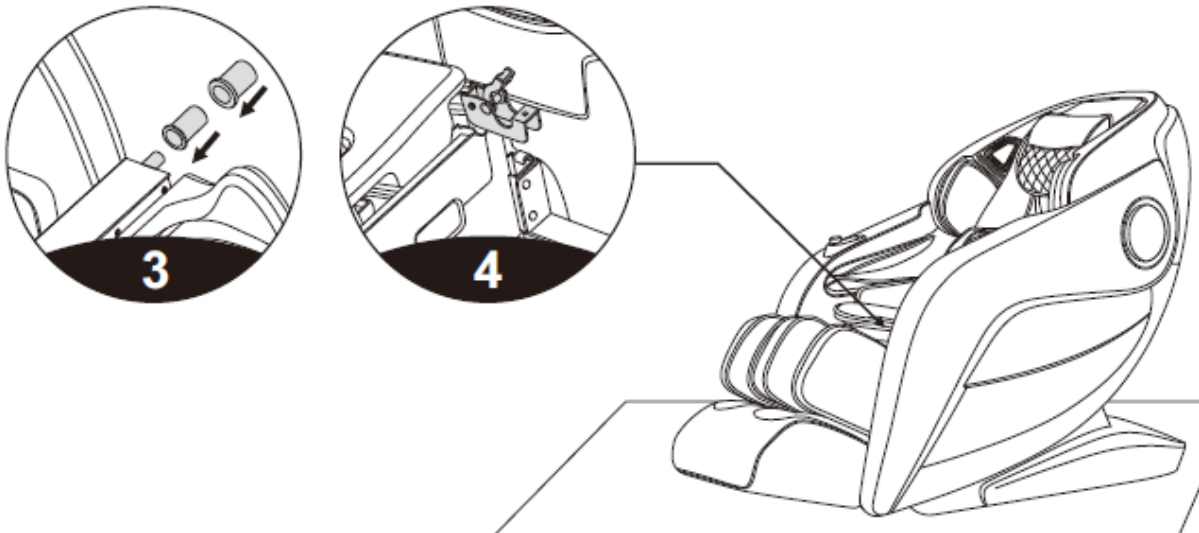

Then slide the leg rest into the holders (5).

Then fasten the covers with 2x screws M5x14 - 12.9 and 2x washers 6x12x1.5 (Fig. 6).

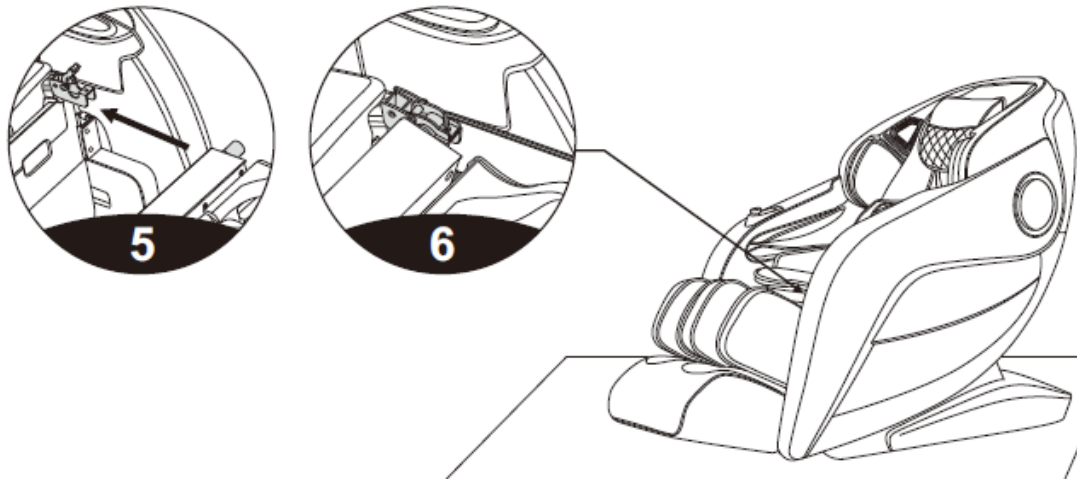

Attach the cover (Fig. 7).

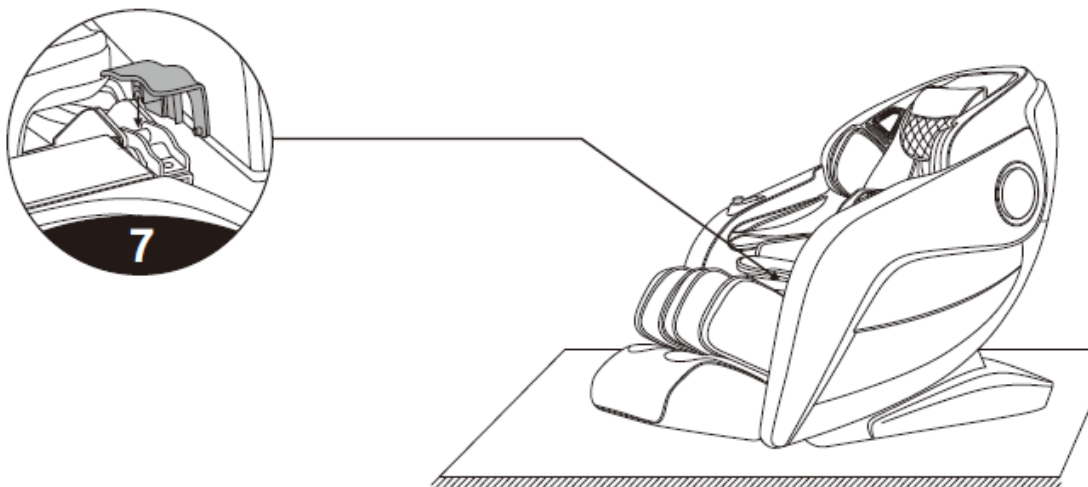

PILLOWS

The cushions are fastened with a zipper for the backrest (1), the cushions for the headrest with Velcro (2).

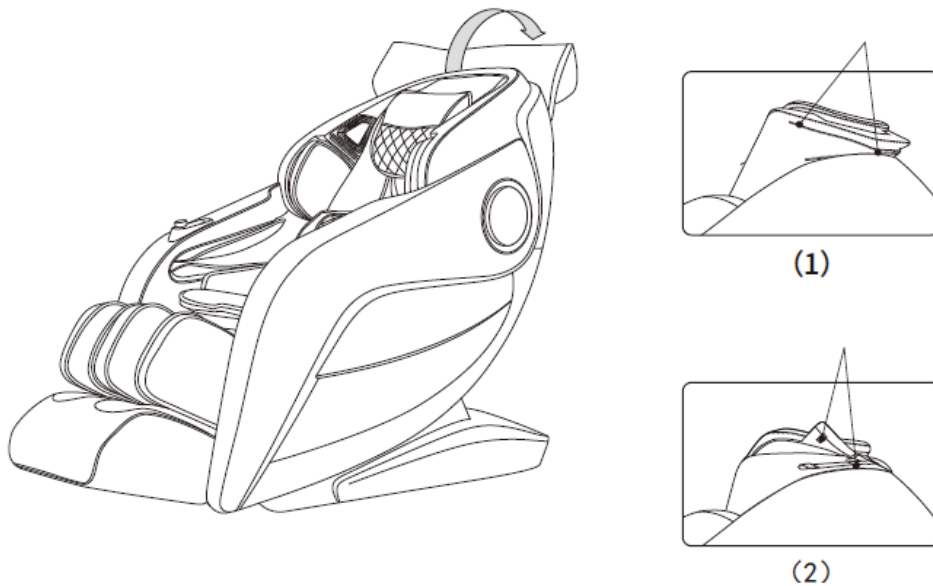

FLOOR PROTECTION

We recommend using floor protection such as carpets or mats. The weight of the chair could damage the wooden floor.

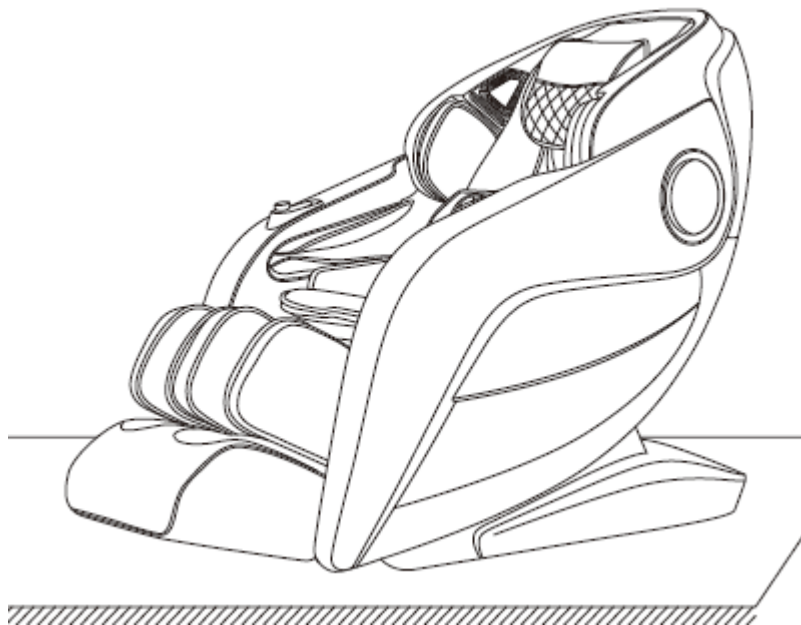

TRANSPORT

Before moving, make sure that you have switched off the chair and pulled it out of the power.

You need two people to move.

One person lifts the chair by the footrest and the other pushes by the backrest, thus placing the chair on the wheels. Do not pull the chair by the armrests.

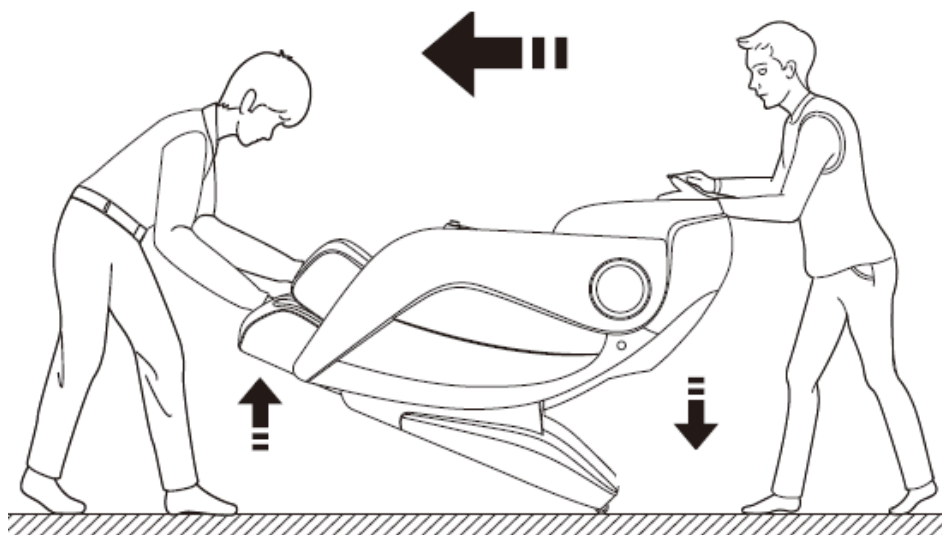

SPECIFICATIONS

Model:	A701
Configuration:	2
Name:	Massage armchair
Rated voltage:	110-120V 60 Hz 220-240V 50Hz / 60Hz
Rated power input	220 W
Operation time	20 min
Safety:	Class I

ENVIRONMENT PROTECTION

After the product lifespan expired or if the possible repairing is uneconomic, dispose it according to the local laws and environmentally friendly in the nearest scrapyards.

By proper disposal you will protect the environment and natural sources. Moreover, you can help protect human health. If you are not sure in correct disposing, ask local authorities to avoid law violation or sanctions.

Don't put the batteries among house waste but hand them in to the recycling place.

TERMS AND CONDITIONS OF WARRANTY, WARRANTY CLAIMS

General Conditions of Warranty and Definition of Terms

All Warranty Conditions stated here under determine Warranty Coverage and Warranty Claim Procedure. Conditions of Warranty and Warranty Claims are governed by Act No. 89/2012 Coll. Civil Code, and Act No. 634/1992 Coll., Consumer Protection, as amended, also in cases that are not specified by these Warranty rules.

The seller is SEVEN SPORT s.r.o. with its registered office in Strakonická street 1151/2c, Prague 150 00, Company Registration Number: 26847264, registered in the Trade Register at Regional Court in Prague, Section C, Insert No. 116888.

According to valid legal regulations it depends whether the Buyer is the End Customer or not.

“The Buyer who is the End Customer” or simply the “End Customer” is the legal entity that does not conclude and execute the Contract in order to run or promote his own trade or business activities.

“The Buyer who is not the End Customer” is a Businessman that buys Goods or uses services for the purpose of using the Goods or services for his own business activities. The Buyer conforms to the General Purchase Agreement and business conditions.

These Conditions of Warranty and Warranty Claims are an integral part of every Purchase Agreement made between the Seller and the Buyer. All Warranty Conditions are valid and binding, unless otherwise specified in the Purchase Agreement, in the Amendment to this Contract or in another written agreement.

Warranty Conditions

Warranty Period

The Seller provides the Buyer a 24 months Warranty for Goods Quality, unless otherwise specified in the Certificate of Warranty, Invoice, Bill of Delivery or other documents related to the Goods. The legal warranty period provided to the Consumer is not affected.

By the Warranty for Goods Quality, the Seller guarantees that the delivered Goods shall be, for a certain period of time, suitable for regular or contracted use, and that the Goods shall maintain its regular or contracted features.

Batteries

6-month battery warranty – we guarantee that battery's nominal capacity does not fall below 70% of its total capacity within 6 months of the product's sale.

The Warranty does not cover defects resulting from (if applicable):

- User's fault, i.e. product damage caused by unqualified repair work, improper assembly, insufficient insertion of seat post into frame, insufficient tightening of pedals and cranks
- Improper maintenance
- Mechanical damages
- Regular use (e.g. wearing out of rubber and plastic parts, moving mechanisms, joints, wear of brake pads/blocks, chain, tires, cassette/multi wheel etc.)
- Unavoidable event, natural disaster
- Adjustments made by unqualified person
- Improper maintenance, improper placement, damages caused by low or high temperature, water, inappropriate pressure, shocks, intentional changes in design or construction etc.

Warranty Claim Procedure

The Buyer is obliged to check the Goods delivered by the Seller immediately after taking the responsibility for the Goods and its damages, i.e. immediately after its delivery. The Buyer must check the Goods so that he discovers all the defects that can be discovered by such check.

When making a Warranty Claim the Buyer is obliged, on request of the Seller, to prove the purchase and validity of the claim by the Invoice or Bill of Delivery that includes the product's serial number, or eventually by the documents without the serial number. If the Buyer does not prove the validity of the Warranty Claim by these documents, the Seller has the right to reject the Warranty Claim.

If the Buyer gives notice of a defect that is not covered by the Warranty (e.g. in the case that the Warranty Conditions were not fulfilled or in the case of reporting the defect by mistake etc.), the Seller is eligible to require a compensation for all the costs arising from the repair. The cost shall be calculated according to the valid price list of services and transport costs.

If the Seller finds out (by testing) that the product is not damaged, the Warranty Claim is not accepted. The Seller reserves the right to claim a compensation for costs arising from the false Warranty Claim.

In case the Buyer makes a claim about the Goods that is legally covered by the Warranty provided by the Seller, the Seller shall fix the reported defects by means of repair or by the exchange of the damaged part or product for a new one. Based on the agreement of the Buyer, the Seller has the right

to exchange the defected Goods for a fully compatible Goods of the same or better technical characteristics. The Seller is entitled to choose the form of the Warranty Claim Procedures described in this paragraph.

The Seller shall settle the Warranty Claim within 30 days after the delivery of the defective Goods, unless a longer period has been agreed upon. The day when the repaired or exchanged Goods is handed over to the Buyer is considered to be the day of the Warranty Claim settlement. When the Seller is not able to settle the Warranty Claim within the agreed period due to the specific nature of the Goods defect, he and the Buyer shall make an agreement about an alternative solution. In case such agreement is not made, the Seller is obliged to provide the Buyer with a financial compensation in the form of a refund.

CZ
SEVEN SPORT s.r.o.

Registered Office: Strakonická 1151/2c, Praha 5, 150 00, ČR
Headquarters: Dělnická 957, Vítkov, 749 01
Warranty & Service: Čermenská 486, Vítkov 749 01

CRN: 26847264
VAT ID: CZ26847264

Phone: +420 556 300 970
E-mail: eshop@insportline.cz
reklamace@insportline.cz
servis@insportline.cz

Web: www.inSPORTline.cz

SK
inSPORTline s.r.o.

Headquarters, warranty & service center: Električná 6471, Trenčín 911 01, SK

CRN: 36311723
VAT ID: SK2020177082

Phone: +421(0)326 526 701
E-mail: objednavky@insportline.sk
reklamacie@insportline.sk
servis@insportline.sk

Web: www.inSPORTline.sk