



**USER MANUAL – EN**  
**IN 22340 E-scooter W-TEC Teneur 10”**

# CONTENTS

- SAFETY INSTRUCTIONS..... 3
- PRODUCT DESCRIPTION ..... 4
- CONTROL PANEL ..... 5
- DISPLAY..... 5
  - DISPLAY ..... 6
  - SETTINGS ..... 7
- FOLDING AND UNFOLDING..... 9
- BATTERY ..... 9
  - BATTERY CAPACITY ..... 10
- BATTERY CHARGING..... 10
- USE ..... 10
- RIDING TECHNIQUE ..... 11
- CLEANING AND MAINTENANCE ..... 11
- STORAGE ..... 11
- TECHNICAL SPECIFICATIONS ..... 12
- ENVIRONMENT PROTECTION ..... 12
- TERMS AND CONDITIONS OF WARRANTY, WARRANTY CLAIMS..... 12

## SAFETY INSTRUCTIONS

- Read the manual carefully and keep it for future reference.
- The scooter is designed to carry one person at the same time.
- Wear a helmet and other protective equipment, incl. proper boots.
- Do not ride on dangerous or ineligible roads.
- Before the first ride, try to control the scooter in the open spaces. If you are not sure, ask a more experienced person for advice.
- Avoid dangerous maneuvers or one-hand steering while riding.
- When riding, keep both feet on the footboard.
- Do not drive directly over an obstacle higher than 3 cm, otherwise you can lose balance and cause yourself injury or damage to the product.
- On uneven or bumpy roads, slow down and ride with caution. Do not endanger yourself or others by careless riding.
- Before riding, it is necessary to set the correct handlebar height for your safety.
- Do not ride into the water, oil or on frozen surfaces.
- Do not immerse the scooter in water. The battery or motor will be destroyed.
- If possible, do not ride in poor weather conditions. Be extra caution during dark.
- Always make sure that you do not violate local regulations and laws before using the product. The use of these and similar devices is not permitted everywhere. If in doubt, contact your local authorities.
- Check that all parts are well held and the screws are not loosened. Ex. tighten them or contact a service center.
- Unauthorized modifications or maintenance will reduce the safety of the equipment.
- Improper use can lead to serious (fatal) injury or damage.
- Check the product regularly for wear. Replace worn parts immediately.
- Do not use a damaged product. Do not use the product if sharp edges appear.
- Follow the manual for maintenance and use. Do not disassemble the device yourself.
- Check the battery level before riding. If it is not fully charged, do not start riding.
- The device is for personal use only. Commercial use is not allowed.
- Be careful while riding. Never ride after drinking alcohol or under the influence of drugs. Do not carry anything on the device.
- Always keep the speed under control and be careful. Keep good vision around the area. Do not exceed speed or weight limits to avoid injury.
- Keep your feet relaxed and your knees slightly bent when riding on an uneven surface.
- In the event of an accident, do not leave and wait for assistance.
- When riding in a group, keep a sufficient distance to avoid collision.
- Remember that your current height is greater when standing on the scooter than without it. Try to keep your balance and avoid too narrow places.
- Other activities (phoning, listening to music) can significantly reduce your riding attention. Don't be distracted.
- Check the condition of the tires regularly. Replace worn out immediately.

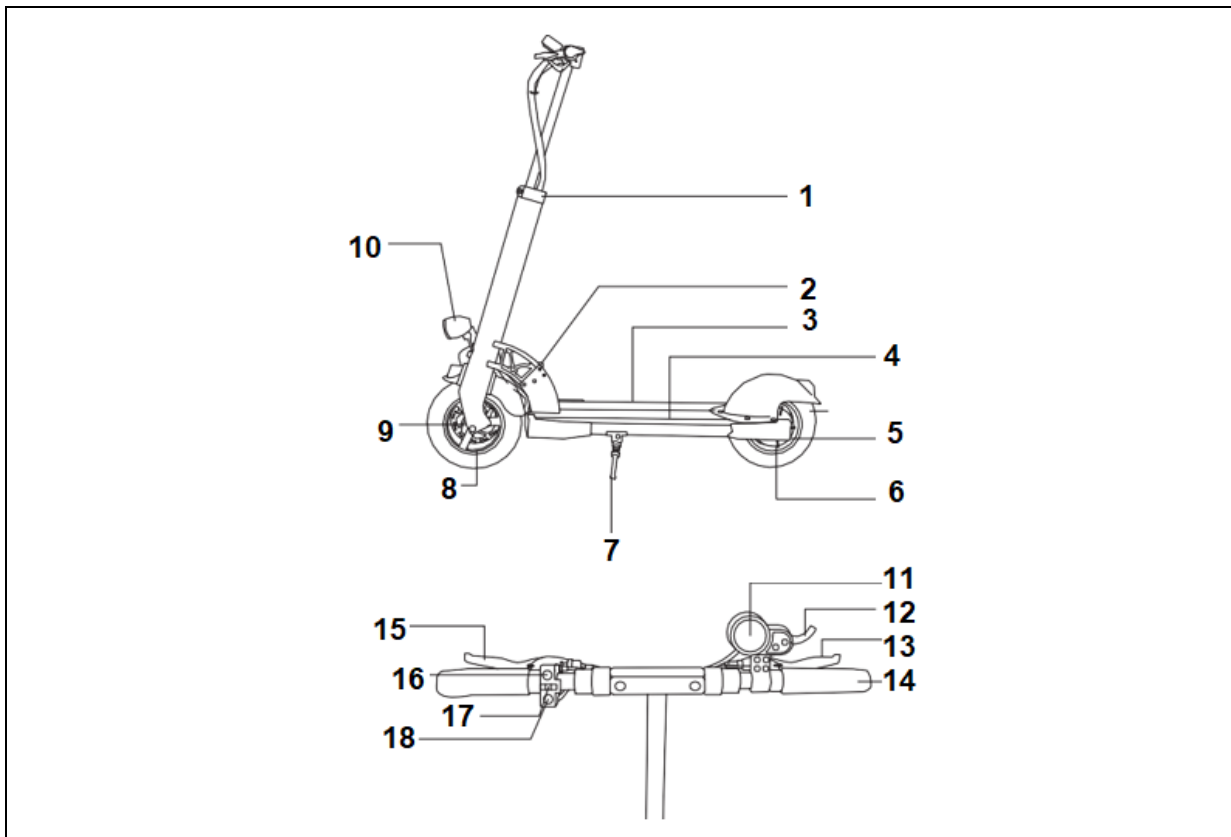

- Weight limit: 120 kg

## PRODUCT DESCRIPTION



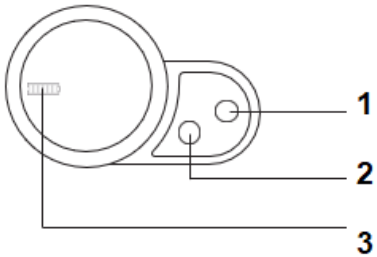

1.	Quick release lever
2.	Button for folding / unfolding the handlebars
3.	Charging port
4.	Footboard
5.	Reflections
6.	Drive
7.	Stand
8.	Front wheel
9.	Brake
10.	Light
11.	Display
12.	Speed control lever
13.	Brake
14.	Handle
15.	Brake
16.	Light control
17.	Flashing light

## CONTROL PANEL

	1.	Turn on / off 
	2.	Mode
	3.	Battery indicator

Press the  button for 3 seconds to turn on.

Once the scooter is running, pressing the  button, the gear level will start flashing and use the Mode button to adjust the gear (1, 2 and 3).

To turn off, press the  button for 3 seconds. The scooter also automatically turn off after 3 minutes of inactivity.

## DISPLAY

Battery status (5 segments is maximum).

Speed, current distance traveled, total distance traveled, etc.

Use the Mode button to display the following information: operating time, distance traveled in km, total distance traveled, battery voltage (Vol).



Display shows: power indicator, error messages, headlight, cruise control, gear, total mileage, current mileage, real time voltage, electric current, operation time, start-up mode.

# DISPLAY

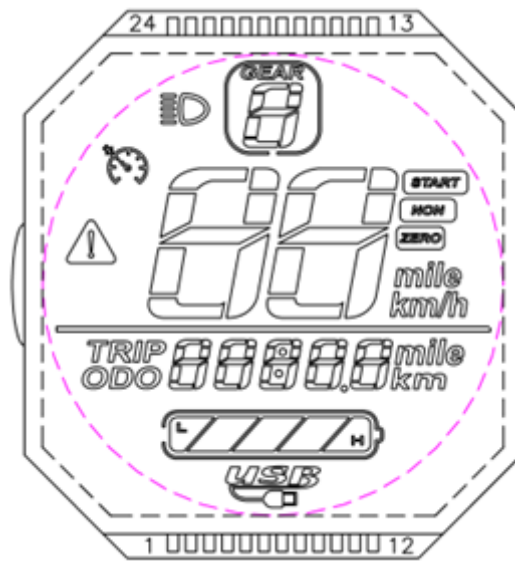

Battery status



Multi-function area display

- ODO – total mileage
- TRIP – current mileage
- V – real time voltage
- TIME – operation time
- E – error code

If error starts to flicker, press ON/OFF button, the display will show current error message	
ERRO 1	Motor problem
ERRO 2	
ERRO 3	Controller problem
ERRO 4	Power brake problem
ERRO 5	Under voltage protection
ERRO 6	Communication failure, scooter to the controller
ERRO 7	Communication failure, controller to the scooter



Speed

- Units miles/hour or km/hour



Gear

- Press MODE to change gear from 0 to 3 highest (highest gear allows you to increase speed limit)



Headlight

- Hold the MODE button to turn on/off headlight.



Cruise control

- After riding in constant speed for 5 seconds, cruise symbol will show and turn on. If you want to turn off the cruise control, speed up or slow down.



Start

- Shows how the scooter start up, with motor assistance or without



USB

## SETTINGS

To enter settings, hold MODE + ON/OFF button,

Press ON/OFF to increase parameter, press MODE to decrease parameter.

Press MODE + MODE key to save and exit the settings.

P02 Units	0 KM 1 Miles Default: 0
P06 Wheel diameter, unit: inches	Accuracy: 0.1 Default: 10
P07 Speed measuring magnet	Range: 1 – 100 Default: 30
P09 Start	0 Zero start 1 Non-zero start Default: 0
P15 Maximum motor speed, unit: % of factory settings speed limit	Maximum: 100 Default: 57

P16 Cruise control	0 off 1 on
P99 Restore default setting	When you enter P99 setting, hold MODE button for 5-6 seconds
ODO Reset total distance	When you enter ODO settings, press MODE and then hold it for 5-6 seconds

To turn on the scooter, press ON/OFF button. To turn off the scooter hold ON/OFF button.

Hold MODE + ON/OFF button to enter settings, press ON/OFF button to set parameter.

Press MODE button to change speed mode (gear) from 0 (lowest) to 3 (highest).

Pull accelerator to speed up, release to slow down.

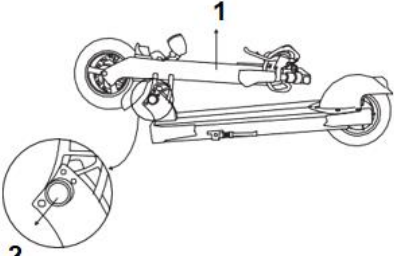
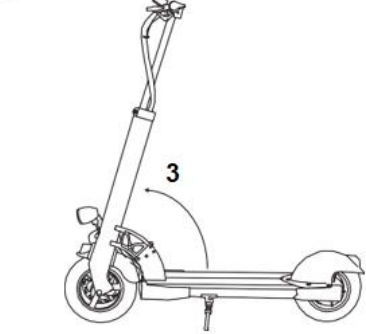
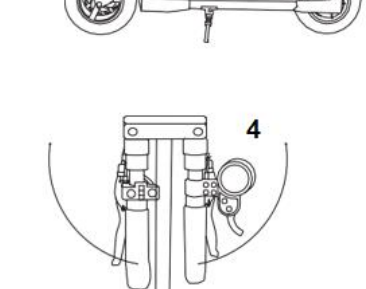
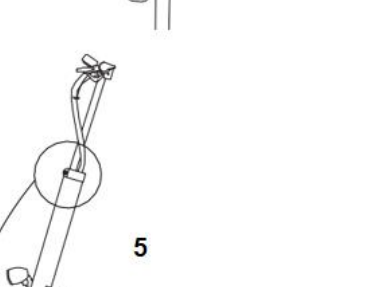
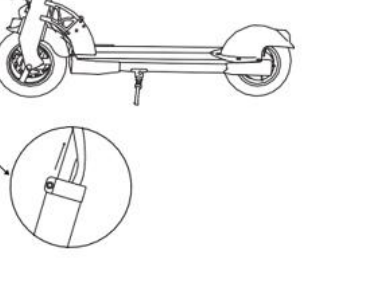

## FOLDING AND UNFOLDING

	<p>1. Raise the handlebars slightly</p>
	<p>2. Press the button</p>
	<p>3. Raise the handlebars</p>
	<p>4. Unfold the handles</p>
	<p>5. Set the desired handlebar height</p>

To fold, repeat the steps in reverse order of the layout

## BATTERY

**6-month battery warranty – we guarantee that battery's nominal capacity does not fall below 70% of its total capacity within 6 months of the product's sale.**

For proper operation and safe use of the battery, follow the instructions in the manual. Stop using the battery immediately if the battery is damaged, leaks liquid or you smell abnormal odor.

- Battery lifespan is limited. If you use a battery that exceeds normal lifespan, the charging frequency may increase, and the scooter range will be reduced.
- Do not open or throw of the battery in a fire. Do not insert foreign objects into the battery.
- Do not touch the battery with metal objects. The battery may explode or be damaged.
- Use only the original charger.
- Follow local regulations and laws while driving.
- You can charge the battery continuously.
- The ideal battery charging temperature is +10 ° C to +30 ° C.
- If you use the battery for an extended period, its temperature will be higher. This is a normal battery condition.
- If you use the battery in a cold environment, the range is lower.
- Do not repair or modify the battery yourself.

## BATTERY CAPACITY

Volts	Capacity
55,2 – 52,8	Fully charged
52,3 – 49,8	High capacity
49,3 – 43,9	Medium capacity
43,5 – 41,5	Low capacity

## BATTERY CHARGING

- When the red light is on, the battery is charging.
- When the green light is on, the battery is fully charged.
- Switch off the scooter before maintenance.
- Keep the battery away from flammable objects.
- Use only the original charger.
- Do not use the scooter while charging.
- Never let the battery discharge completely.

## USE

- Before use, make sure that all parts are properly assembled, tightened and not damaged.
- Check the brakes.
- Check that the folding mechanism is properly locked.
- Make sure the battery is properly charged.
- Make sure the tires are in good condition.
- Check the handlebar. It must be properly tightened.
- Do not drive on slippery surfaces.
- Wear personal protective equipment including a helmet and a sturdy shoe.
- Do not use if outdoor conditions are poor.

- Moisture reduces braking efficiency.

## RIDING TECHNIQUE

- Know the scooter before first use and test your ability to control this product.
- Turn continuously and brake safely having enough free space.
- Practice your first ride in an open area without obstacles.
- Never let distract your mind during riding.

**Foot position** – put your foot on the board as close to the front part as possible. Let your other foot on the ground. Make sure the route is clean and free. To start riding, push yourself forwards (like on a non-motorized scooter). Push off with the foot that is on the ground. Immediately after pressing the throttle downwards, tilt your body forwards as a prevention from falling back while increasing your speed. Avoid excessive body pressing on the handlebars during speed changing. One foot is at front and the second one is back. It is comfortable to place the feet like on a skateboard for optimal stability.

**NOTE:** Riding on a scooter can be dangerous. You use the product on your own responsibility and be familiar with all the safety precautions before riding.

**Turning** – it is the same as on a surf or snowboard. The handlebar should be parallel to the body. Before turning look at the approaching direction to be sure the operation is safe.

**Braking** – shift your weight backwards so that the braking is realized through your feet and not through handlebar and steering system. Learn well to adjust the gravity center during stopping to avoid turning over or excessive wearing of the braking and steering system

## CLEANING AND MAINTENANCE

- The scooter must be switched off, disconnected from the charger and the charging port must be covered before cleaning or maintenance.
- Clean the scooter with a damp cloth and a mild detergent.
- Do not use solvents or other aggressive cleaning agents.
- Keep the water out of the charging port.
- Never immerse the scooter.
- Do not use high-pressure cleaners.
- If the tire pressure is low, inflate it.
- If you need to replace tires / inner tubes, please contact your specialist dealer or manufacturer.
- You can adjust the brake stiffness by loosening the M5 screw. Loosen the screw to the right, tighten it to the left.

## STORAGE

- Store in a dry and shady place.
- Avoid storage if the room temperature exceeds 50 ° C.
- Charge the battery at least once a month. Battery life is lower in cold conditions.

## TECHNICAL SPECIFICATIONS

Wheel size	10"
Speed	35-40 km/h
Charging time	6-7 h
Power	500W
Charger	INPUT 100-240VAC / 50 ~ 60HZ, OUTPUT DC54,6V / 2A
Battery	48V 13Ah
Range	35 km
Maximum incline	15°
Maximal load capacity	120 kg
Weight	19,2 kg
Folded dimensions	110x26x37 cm
Unfolded dimensions	110x57x80-120 cm
Package size	114x30,6x34,5 cm
Use temperature	-10 – 45 °
Brakes	Disk + electric
Display	Digital LCD
Lights	Front and rear LEDs
Flashers	Yes
Material	Aluminium alloy

\*Depends on gear, tilt, ambient temperature, user weight, etc.

## ENVIRONMENT PROTECTION

After the product lifespan expired or if the possible repairing is uneconomic, dispose it according to the local laws and environmentally friendly in the nearest scrapyard.

By proper disposal you will protect the environment and natural sources. Moreover, you can help protect human health. If you are not sure in correct disposing, ask local authorities to avoid law violation or sanctions.

Don't put the batteries among house waste but hand them in to the recycling place.

## TERMS AND CONDITIONS OF WARRANTY, WARRANTY CLAIMS

### General Conditions of Warranty and Definition of Terms

All Warranty Conditions stated here under determine Warranty Coverage and Warranty Claim Procedure. Conditions of Warranty and Warranty Claims are governed by Act No. 89/2012 Coll. Civil Code, and Act No. 634/1992 Coll., Consumer Protection, as amended, also in cases that are not specified by these Warranty rules.

The seller is SEVEN SPORT s.r.o. with its registered office in Strakonická street 1151/2c, Prague 150 00, Company Registration Number: 26847264, registered in the Trade Register at Regional Court in Prague, Section C, Insert No. 116888.

According to valid legal regulations it depends whether the Buyer is the End Customer or not.

“The Buyer who is the End Customer” or simply the “End Customer” is the legal entity that does not conclude and execute the Contract in order to run or promote his own trade or business activities.

“The Buyer who is not the End Customer” is a Businessman that buys Goods or uses services for the purpose of using the Goods or services for his own business activities. The Buyer conforms to the General Purchase Agreement and business conditions.

These Conditions of Warranty and Warranty Claims are an integral part of every Purchase Agreement made between the Seller and the Buyer. All Warranty Conditions are valid and binding, unless otherwise specified in the Purchase Agreement, in the Amendment to this Contract or in another written agreement.

### **Warranty Conditions**

#### Warranty Period

The Seller provides the Buyer a 24 months Warranty for Goods Quality, unless otherwise specified in the Certificate of Warranty, Invoice, Bill of Delivery or other documents related to the Goods. The legal warranty period provided to the Consumer is not affected.

By the Warranty for Goods Quality, the Seller guarantees that the delivered Goods shall be, for a certain period of time, suitable for regular or contracted use, and that the Goods shall maintain its regular or contracted features.

#### **The Warranty does not cover defects resulting from (if applicable):**

- User’s fault, i.e. product damage caused by unqualified repair work, improper assembly, insufficient insertion of seat post into frame, insufficient tightening of pedals and cranks
- Improper maintenance
- Mechanical damages
- Regular use (e.g. wearing out of rubber and plastic parts, moving mechanisms, joints, wear of brake pads/blocks, chain, tires, cassette/multi wheel etc.)
- Unavoidable event, natural disaster
- Adjustments made by unqualified person
- Improper maintenance, improper placement, damages caused by low or high temperature, water, inappropriate pressure, shocks, intentional changes in design or construction etc.

### **Warranty Claim Procedure**

The Buyer is obliged to check the Goods delivered by the Seller immediately after taking the responsibility for the Goods and its damages, i.e. immediately after its delivery. The Buyer must check the Goods so that he discovers all the defects that can be discovered by such check.

When making a Warranty Claim the Buyer is obliged, on request of the Seller, to prove the purchase and validity of the claim by the Invoice or Bill of Delivery that includes the product’s serial number, or eventually by the documents without the serial number. If the Buyer does not prove the validity of the Warranty Claim by these documents, the Seller has the right to reject the Warranty Claim.

If the Buyer gives notice of a defect that is not covered by the Warranty (e.g. in the case that the Warranty Conditions were not fulfilled or in the case of reporting the defect by mistake etc.), the Seller is eligible to require a compensation for all the costs arising from the repair. The cost shall be calculated according to the valid price list of services and transport costs.

If the Seller finds out (by testing) that the product is not damaged, the Warranty Claim is not accepted. The Seller reserves the right to claim a compensation for costs arising from the false Warranty Claim.

In case the Buyer makes a claim about the Goods that is legally covered by the Warranty provided by the Seller, the Seller shall fix the reported defects by means of repair or by the exchange of the damaged part or product for a new one. Based on the agreement of the Buyer, the Seller has the right to exchange the defected Goods for a fully compatible Goods of the same or better technical characteristics. The Seller is entitled to choose the form of the Warranty Claim Procedures described in this paragraph.

The Seller shall settle the Warranty Claim within 30 days after the delivery of the defective Goods, unless a longer period has been agreed upon. The day when the repaired or exchanged Goods is handed over to the Buyer is considered to be the day of the Warranty Claim settlement. When the Seller is not able to settle the Warranty Claim within the agreed period due to the specific nature of the Goods defect, he and the Buyer shall make an agreement about an alternative solution. In case such agreement is not made, the Seller is obliged to provide the Buyer with a financial compensation in the form of a refund.

**CZ**  
**SEVEN SPORT s.r.o.**

Registered Office: Strakonická 1151/2c, Praha 5, 150 00, ČR  
Headquarters: Dělnická 957, Vítkov, 749 01  
Warranty & Service: Čermenská 486, Vítkov 749 01

CRN: 26847264  
VAT ID: CZ26847264

Phone: +420 556 300 970  
E-mail: eshop@insportline.cz  
reklamace@insportline.cz  
servis@insportline.cz

Web: www.inSPORTline.cz

**SK**  
**inSPORTline s.r.o.**

Headquarters, warranty & service center: Električná 6471, Trenčín 911 01, SK

CRN: 36311723  
VAT ID: SK2020177082

Phone: +421(0)326 526 701  
E-mail: objednavky@insportline.sk  
reklamacie@insportline.sk  
servis@insportline.sk

Web: www.inSPORTline.sk