



USER MANUAL – EN
IN 2055 Digger WORKER



CONTENTS

INTRODUCTION..... 3

SAFETY WARNINGS..... 3

COMPONENTS..... 3

ASSEMBLE INSTRUCTIONS 4

MAINTENANCE 4

TERMS AND CONDITIONS OF WARRANTY, WARRANTY CLAIMS..... 5









INTRODUCTION

Thank you for purchasing this product. Please, check if the package contains all the listed components before assembly. If there are parts missing or broken, contact our shop or customer service.

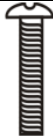
SAFETY WARNINGS

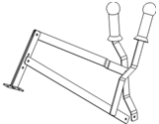
1. This device must be assembled only by an adult.
2. Make sure that all screws and bolts fit well (and are well tightened) before use.
3. This device can be used outdoors.
4. You can place this digger on soft ground (e.g. sand).
5. Children can use this product only under adult supervision.
6. Recommended for children 3 – 6 years of age.
7. Max. seat weight limit: 35 kg.
8. This device is not intended to be used by children under 3 years. They could swallow small parts.
9. Home use only.
10. Keep this manual for possible future use.
11. Never let children play with the device without adult supervision.

COMPONENTS

NO.	PICTURE	NAME	Q'TY	NO.	PICTURE	NAME	Q'TY
1		Seat	1	E1		M6x20 Bolt	2
2		Bucket	1	E13		M5x10 Bolt	1
3		Component 1	1	E14		M5x25 Bolt	2
4		Component 2	1	W1		M6 Safety nut	2
5		Base	1	U3		M5 Safety nut	3
				X3		Metal washer	7

ASSEMBLE INSTRUCTIONS

1. Affix the seat (1) to the component 1 (3) with M6x20 bolts (E1), washers (X3) and M6 safety nuts (W1).
2. Affix the bucket (2) to the component 2 (4) with M5x25 bolts (E14), washers (X3) and M5 safety nuts (U3).
3. Connect the components 2 (4) and 1 (3) together other with M5x10 bolt (E13), washers (X3) and M5 safety nut (U3).
4. Insert the upper component into the base and finish the assembly.

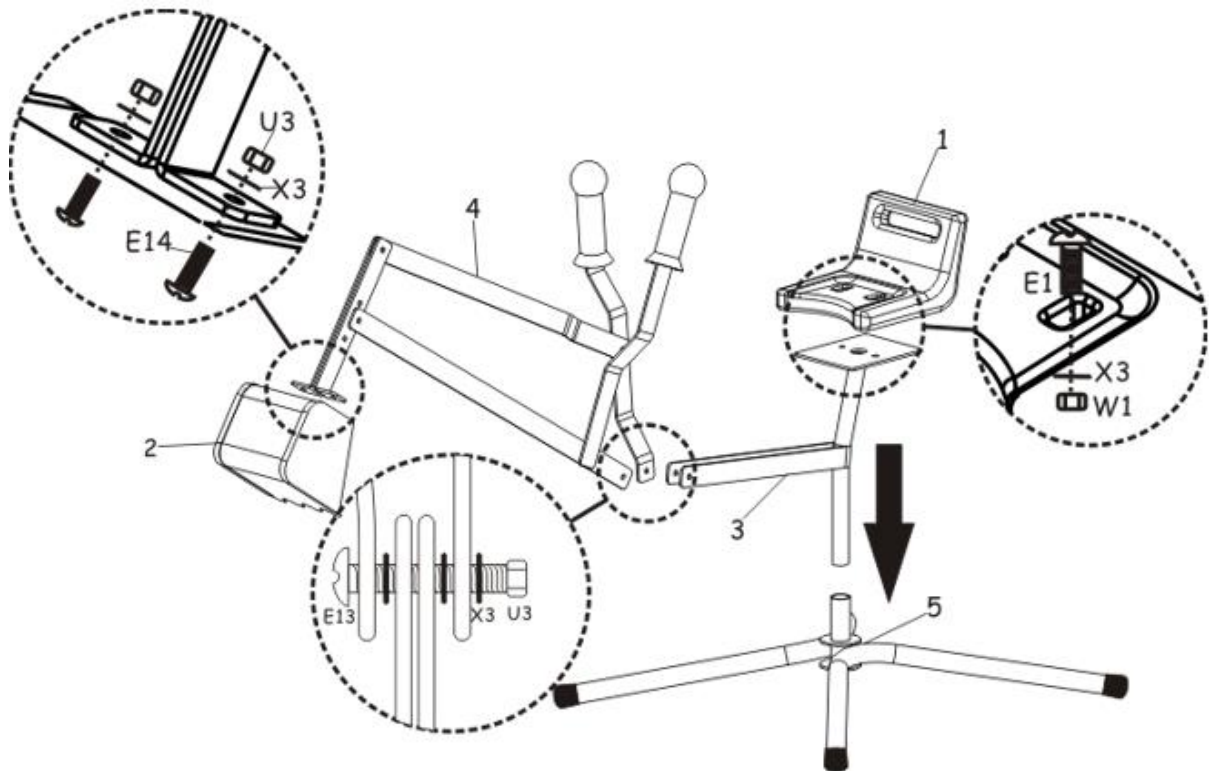

MAINTENANCE

WARNING

- The assembly should be done only according to the instructions of manufacturer.
- Regularly check all components for wear or tearing.
- Make sure that fixing and anchorage is secure at all times.
- Check metal components for corrosion.
- Don't use this device, if there are parts that are damaged or worn.
- Pay attention to all warnings above to avoid damage or injury.

TERMS AND CONDITIONS OF WARRANTY, WARRANTY CLAIMS

General Conditions of Warranty and Definition of Terms

All Warranty Conditions stated hereunder determine Warranty Coverage and Warranty Claim Procedure. Conditions of Warranty and Warranty Claims are governed by Act No. 40/1964 Coll. Civil Code, Act No. 513/1991 Coll., Commercial Code, and Act No. 634/1992 Coll., Consumer Protection Act, as amended, also in cases that are not specified by these Warranty rules.

The seller is SEVEN SPORT s.r.o. with its registered office in Borivojova Street 35/878, Prague 13000, Company Registration Number: 26847264, registered in the Trade Register at Regional Court in Prague, Section C, Insert No. 116888.

According to valid legal regulations it depends whether the Buyer is the End Customer or not.

“The Buyer who is the End Customer” or simply the “End Customer” is the legal entity that does not conclude and execute the Contract in order to run or promote his own trade or business activities.

“The Buyer who is not the End Customer” is a Businessman that buys Goods or uses services for the purpose of using the Goods or services for his own business activities. The Buyer conforms to the General Purchase Agreement and business conditions to the extent specified in the Commercial Code.

These Conditions of Warranty and Warranty Claims are an integral part of every Purchase Agreement made between the Seller and the Buyer. All Warranty Conditions are valid and binding, unless otherwise specified in the Purchase Agreement, in the Amendment to this Contract or in another written agreement.

Warranty Conditions

Warranty Period

The Seller provides the Buyer a 24 months Warranty for Goods Quality, unless otherwise specified in the Certificate of Warranty, Invoice, Bill of Delivery or other documents related to the Goods. The legal warranty period provided to the Consumer is not affected.

By the Warranty for Goods Quality, the Seller guarantees that the delivered Goods shall be, for a certain period of time, suitable for regular or contracted use, and that the Goods shall maintain its regular or contracted features.

The Warranty does not cover defects resulting from (if applicable):

- User's fault, i.e. product damage caused by unqualified repair work, improper assembly, insufficient insertion of seat post into frame, insufficient tightening of pedals and cranks
- Improper maintenance
- Mechanical damages
- Regular use (e.g. wearing out of rubber and plastic parts, moving mechanisms, joints etc.)
- Unavoidable event, natural disaster
- Adjustments made by unqualified person
- Improper maintenance, improper placement, damages caused by low or high temperature, water, inappropriate pressure, shocks, intentional changes in design or construction etc.

Warranty Claim Procedure

The Buyer is obliged to check the Goods delivered by the Seller immediately after taking the responsibility for the Goods and its damages, i.e. immediately after its delivery. The Buyer must check the Goods so that he discovers all the defects that can be discovered by such check.

When making a Warranty Claim the Buyer is obliged, on request of the Seller, to prove the purchase and validity of the claim by the Invoice or Bill of Delivery that includes the product's serial number, or eventually by the documents without the serial number. If the Buyer does not prove the validity of the Warranty Claim by these documents, the Seller has the right to reject the Warranty Claim.

If the Buyer gives notice of a defect that is not covered by the Warranty (e.g. in the case that the Warranty Conditions were not fulfilled or in the case of reporting the defect by mistake etc.), the Seller is eligible to require a compensation for all the costs arising from the repair. The cost shall be calculated according to the valid price list of services and transport costs.

If the Seller finds out (by testing) that the product is not damaged, the Warranty Claim is not accepted. The Seller reserves the right to claim a compensation for costs arising from the false Warranty Claim.

In case the Buyer makes a claim about the Goods that is legally covered by the Warranty provided by the Seller, the Seller shall fix the reported defects by means of repair or by the exchange of the damaged part or product for a new one. Based on the agreement of the Buyer, the Seller has the right to exchange the defected Goods for a fully compatible Goods of the same or better technical characteristics. The Seller is entitled to choose the form of the Warranty Claim Procedures described in this paragraph.

The Seller shall settle the Warranty Claim within 30 days after the delivery of the defective Goods, unless a longer period has been agreed upon. The day when the repaired or exchanged Goods is handed over to the Buyer is considered to be the day of the Warranty Claim settlement. When the Seller is not able to settle the Warranty Claim within the agreed period due to the specific nature of the Goods defect, he and the Buyer shall make an agreement about an alternative solution. In case such agreement is not made, the Seller is obliged to provide the Buyer with a financial compensation in the form of a refund.



SEVEN SPORT s.r.o.

Registered Office:	Borivojova 35/878, 130 00 Praha 3, Czech Republic
Headquarters:	Delnicka 957, 749 01 Vitkov, Czech Republic
Warranty & Service Centre:	Cermenska 486, 749 01 Vitkov, Czech Republic
CRN:	26847264
VAT ID:	CZ26847264
Phone:	+420 556 300 970
E-mail:	eshop@insportline.cz reklamace@insportline.cz servis@insportline.cz
Web:	www.insportline.cz

SK

INSPORTLIN s.r.o.

Headquarters, Warranty & Service centre:	Elektricka 6471, 911 01 Trencin, Slovakia
CRN: 36311723	
VAT ID: SK2020177082	
Phone:	+421(0)326 526 701
E-mail:	objednavky@insportline.sk reklamacie@insportline.sk servis@insportline.sk
Web:	www.insportline.sk

Date of Sale:

Stamp and Signature of Seller: